

This is a preview of "BPVC-VII-2013". Click here to purchase the full version from the ANSI store.

# ASME Boiler and Pressure Vessel Code

AN INTERNATIONAL CODE

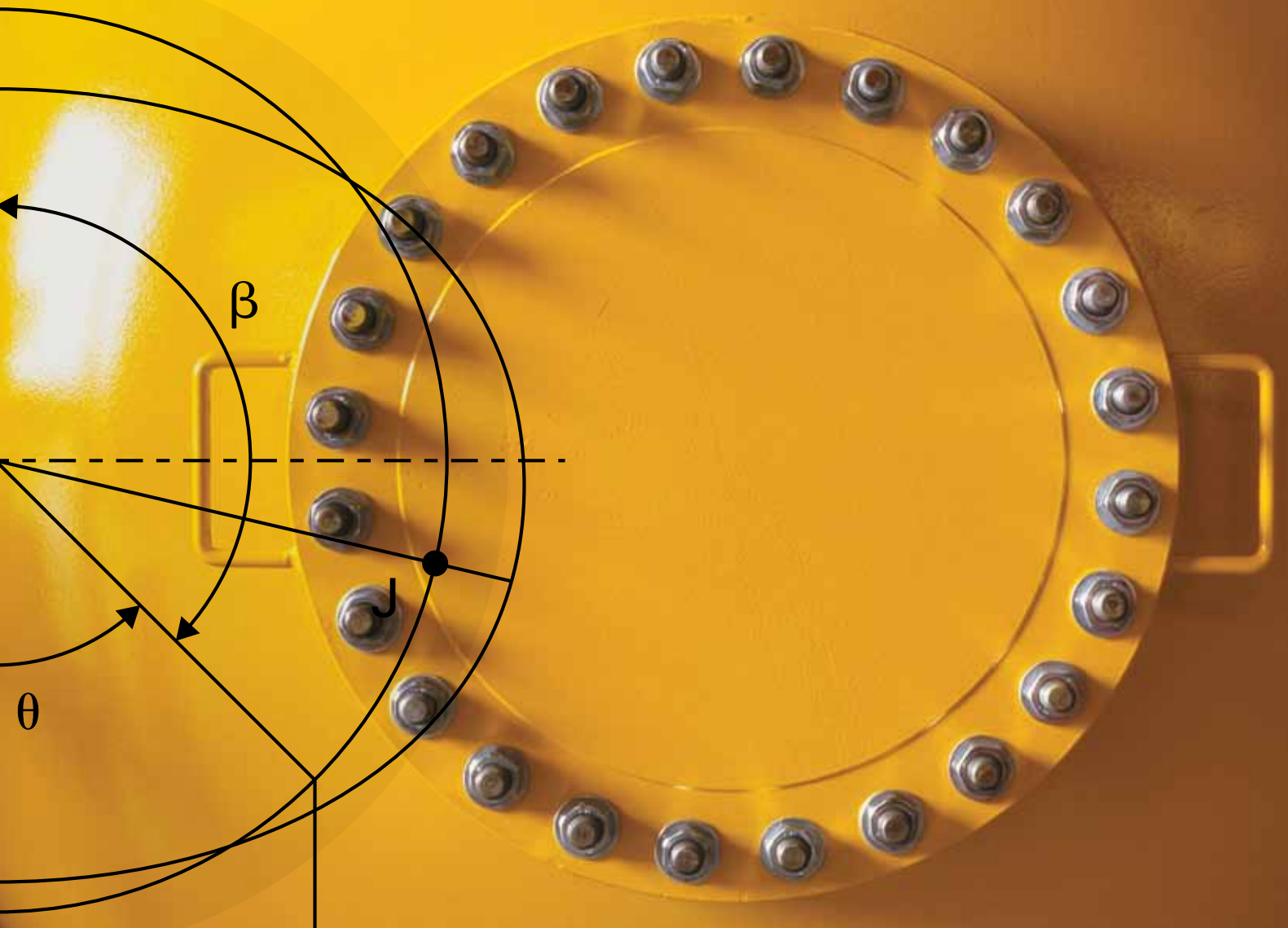

[go.asme.org/bpvc13](http://go.asme.org/bpvc13)

This is a preview of "BPVC-VII-2013". [Click here to purchase the full version from the ANSI store.](#)



ASME's Boiler and Pressure Vessel Code (BPVC) | 2013

# A Century of Safety

When ASME's founders—including Henry R. Worthington, Alexander Lyman Holley and John Edson Sweet, along with other prominent industrialists and technical innovators of the nineteenth century—gathered in New York City for the first time in 1880, the main topic of discussion centered on the need for standardized tools and machine parts as well as uniform work practices in the dawning industrial age. Engineering standards, the founders agreed, would ensure safety, reliability and operational efficiency in machine design and mechanical production.

ASME issued its first standard, *Code for the Conduct of Trials of Steam Boilers*, in 1884. This paper evolved into *Rules for the Construction of Stationary Boilers and for Allowable Working Pressure*—the first edition of ASME's now-legendary *Boiler and Pressure Vessel Code (BPVC)*—issued in 1914 and published in 1915.

The BPVC has grown over the decades to include 28 books and 14,000 pages covering industrial and residential boilers as well as nuclear reactor components, transport tanks, and other forms of pressure vessels. It is kept current by nearly 1,000 volunteer technical experts—

drawn from a balance of interests among industry, government and R&D—who operate in a fully open and transparent manner via consensus process.

The resulting "living document" remains a worldwide model for assuring the safety, reliability and operational efficiency first envisioned by ASME's founders more than a century ago.

## Boilers and Pressure Vessels

Since its first issuance in 1914, ASME's BPVC has pioneered modern standards-development, maintaining a commitment to enhance public safety and technological advancement to meet the needs of a changing world. This "International Historic Mechanical Engineering Landmark" now has been incorporated into the laws of state and local jurisdictions of the United States and nine Canadian provinces.

More than 100,000 copies of the BPVC are in use in 100 countries around the world, with translations into a number of languages. The boiler and pressure-vessel sections of the BPVC have long

been considered essential within such industries as electric power-generation, petrochemical, and transportation, among others.

## Nuclear

ASME has played a vital role in supporting the nuclear industry since its inception, when ASME codes, standards and conformity assessment programs, originally developed for fossil fuel-fired plants, were applied to nuclear power-plant construction. Its widely-adopted *BPVC Section III, Rules for Construction of Nuclear Facility Components*, celebrates 50 years in 2013.

Presently, half of the world's nuclear power plants incorporate all or portions of ASME nuclear codes and standards in their construction, operation, and/or maintenance. Sixty nations generally recognize and apply the BPVC, while 30 of the 44 nuclear nations purchase their nuclear components to specifications contained within ASME's nuclear codes and standards. The nuclear sections of the BPVC reflect the best-practices of industry, while contributing to a full half-century of safety for the general public.

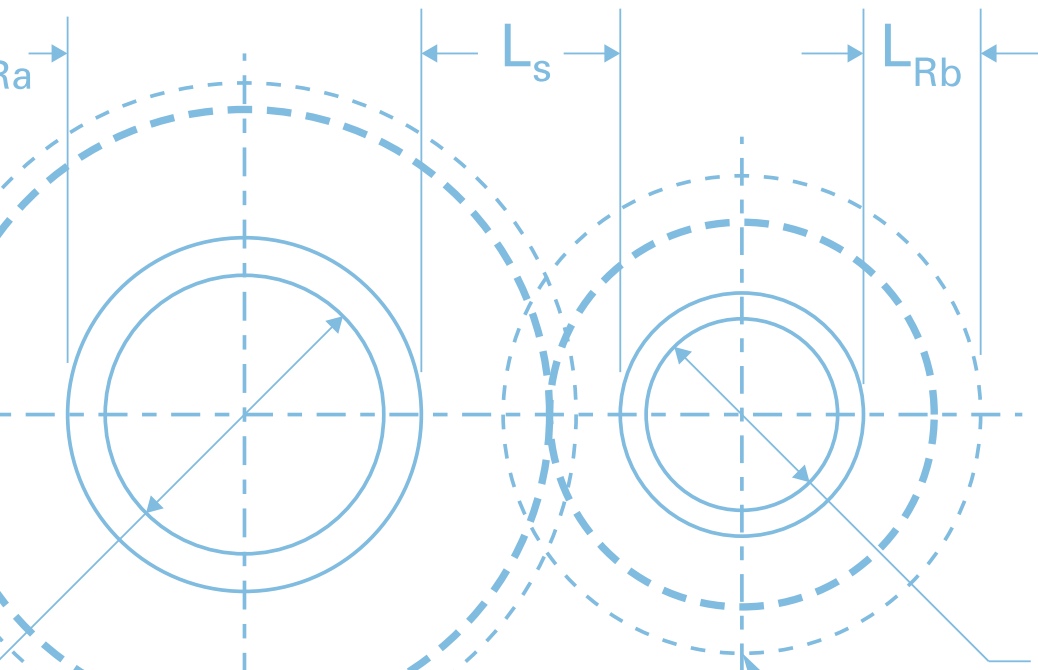

[go.asme.org/bpvc13](http://go.asme.org/bpvc13)

# Power Boilers

## Section I – Power Boilers

Provides requirements for all methods of construction of power, electric, and miniature boilers; high temperature water boilers, heat recovery steam generators, and certain fired pressure vessels to be used in stationary service; and power boilers used in locomotive, portable, and traction service. Rules pertaining to use of the single ASME certification mark with the V, A, M, PP, S, and E designators are also included.

### New! Sección I

Reglas para la construcción de calderas de energía  
(BPVC-I\_ES - 2010)

## Section VII – Care of Power Boilers

Provides guidelines to assist those directly responsible for operating, maintaining, and inspecting power boilers. These boilers include stationary, portable, and traction type boilers, but not locomotive and high-temperature water boilers, nuclear power-plant boilers (see Section XI), heating boilers (see Section VI), pressure vessels, or marine boilers. Guidelines are also provided for operation of auxiliary equipment and appliances that affect the safe and reliable operation of power boilers.

## Referenced BPVC Sections

- BPVC-II, A, B, C, D --**  
Section II, Materials, Parts A through D
- BPVC-V --**  
Section V, Nondestructive Examination
- BPVC-VIII-1 --**  
Section VIII, Rules for Construction of Pressure Vessels, Division 1
- BPVC-IX --**  
Section IX, Welding and Brazing Qualifications

## Referenced ASME Standards

- B1.20.1 --**  
Pipe Threads, General Purpose, Inch
- Twelve Standards from the B16 Series on pipe flanges and fittings
- B31.1 --**  
Power Piping
- B36.10M --**  
Welded and Seamless Wrought Steel Pipe
- PTC 25 --**  
Pressure Relief Devices
- QAI-1 --**  
Qualifications for Authorized Inspection

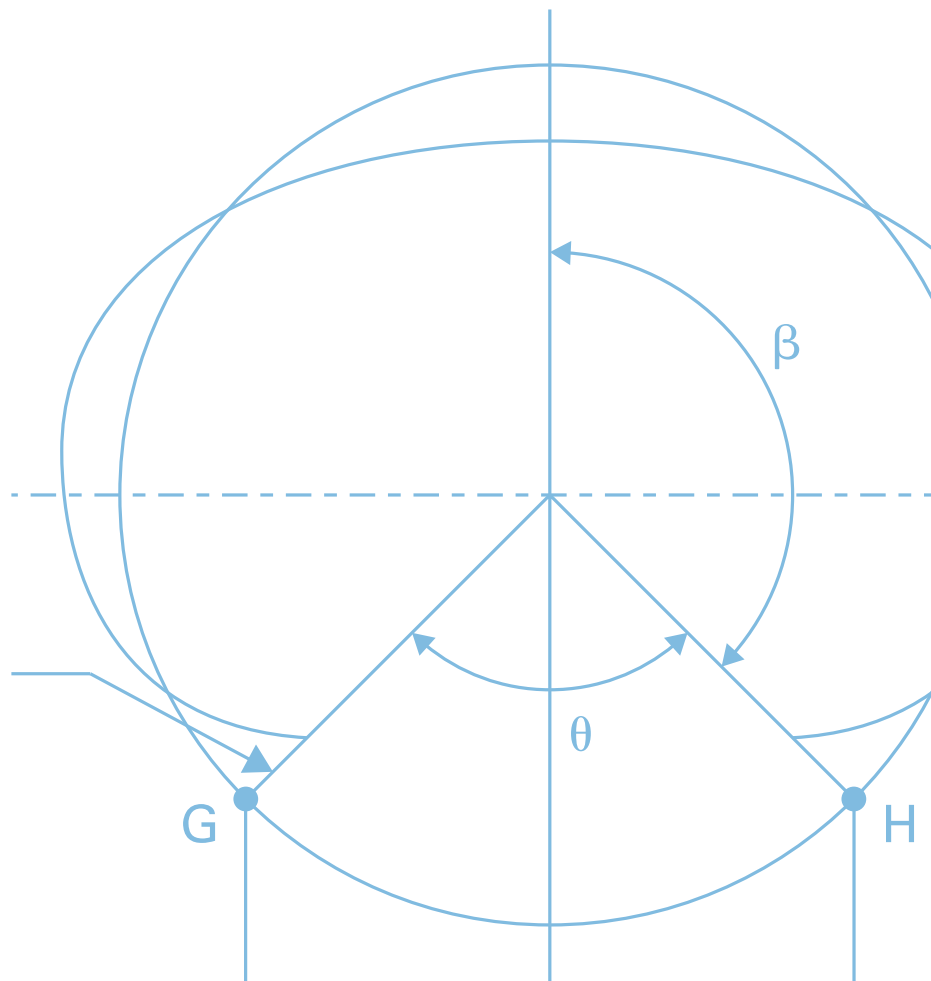

# Power Boilers – Product Certification Packages

**A Designator:**  
Assembly of Power Boilers



**Code Books Required:**  
BPVC-I – Power Boilers  
BPVC-II – Materials  
Part C – Specifications for Welding Rods, Electrodes and Filler Metals  
BPVC-V – Nondestructive Examination  
BPVC-IX – Welding and Brazing Qualifications  
B31.1 – Power Piping

**ORDER NO. BPVCB**

**E Designator:**  
Electric Boilers



**Code Books Required:**  
BPVC-I – Power Boilers  
BPVC-II – Materials  
Part A – Ferrous Materials Specifications  
Part B – Nonferrous Materials Specifications  
Part D – Properties (Customary or Metric)  
B31.1 – Power Piping

**ORDER NO. BPVCE**

**M Designator:**  
Miniature Boilers



**Code Books Required:**  
BPVC-I – Power Boilers  
BPVC-II – Materials  
Part A – Ferrous Materials Specifications  
Part B – Nonferrous Materials Specifications  
Part C – Specifications for Welding Rods, Electrodes and Filler Metals  
Part D – Properties (Customary or Metric)  
BPVC-IX – Welding and Brazing Qualifications  
B31.1 – Power Piping

**ORDER NO. BPVCM**

**PP Designator:**  
Pressure Piping

**S Designator:**  
Power Boilers



**Code Books Required:**  
BPVC-I – Power Boilers  
BPVC-II – Materials  
Part A – Ferrous Materials Specifications  
Part B – Nonferrous Materials Specifications  
Part C – Specifications for Welding Rods, Electrodes and Filler Metals  
Part D – Properties (Customary or Metric)  
BPVC-V – Nondestructive Examination  
BPVC-IX – Welding and Brazing Qualifications  
B31.1 – Power Piping

**ORDER NO. BPVCA**

**V Designator:**  
Boiler Safety Valves



**Code Books Required:**  
BPVC-I – Power Boilers  
BPVC-II – Materials  
Part A – Ferrous Materials Specifications  
Part B – Nonferrous Materials Specifications  
Part C – Specifications for Welding Rods, Electrodes and Filler Metals  
Part D – Properties (Customary or Metric)  
BPVC-IX – Welding and Brazing Qualifications  
PTC 25 – Pressure Relief Devices

**ORDER NO. BPVCV**

## Code Books Required for Use with ASME Product Certification Marks

Note: For books other than the Boiler & Pressure Vessel Code (e.g., B31.1, PTC 25, NQA-1), the required edition as of July 1, 2013 is listed. The specific effective Addenda will be referenced in the applicable Boiler and Pressure Vessel Code section. Later editions of these referenced books will be required if and when referenced by the applicable Boiler and Pressure Vessel Code section.

\* Sections II and IX are not required for assemblers. Section II, Part C, and Section IX are not required for manufacturers if welding and brazing are not within the scope of their work.

Note: Effective January 1, 2013, ASME is replacing its former "code symbol stamps" with one Product Certification Mark, as illustrated on these pages. Individual product certifications will be identified with their respective Product Certification Designators (e.g., "S," "E," etc.).

# Heating Boilers

## Section IV – Heating Boilers

Provides requirements for design, fabrication, installation and inspection of steam heating, hot water heating, hot water supply boilers, and potable water heaters intended for low pressure service that are directly fired by oil, gas, electricity, coal or other solid or liquid fuels. Rules pertaining to use of the single ASME certification mark with the H, HV, and HLW designators are also included.

## Section VI – Care and Operation of Heating Boilers

Covers operation guidelines applicable to steel and cast-iron boilers limited to the operating ranges of Section IV Heating Boilers. Section VI includes guidelines for associated controls and automatic fuel-burning equipment. Also included is a glossary of terms commonly associated with boilers, controls, and fuel burning equipment.

## Referenced BPVC Sections

- BPVC-I --**  
Section I, Rules for Construction of Power Boilers
- BPVC-II, A, B, C, D --**  
Section II, Materials, Parts A through D
- BPVC-IX --**  
Section IX, Welding and Brazing Qualifications

## Referenced ASME Standards

- Seven Standards from the B16 Series on pipe flanges and fittings
- PTC 25 --**  
Pressure Relief Devices
- QAI-1 --**  
Qualifications for Authorized Inspection

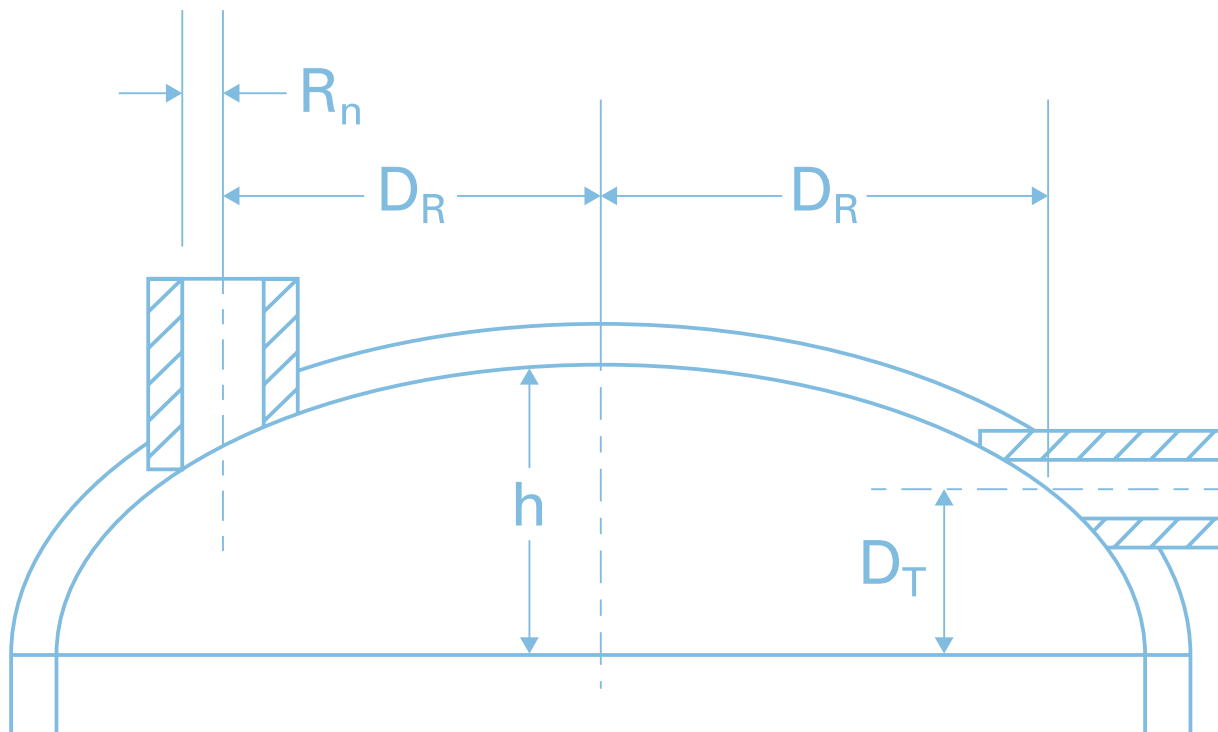

ASME's Boiler and Pressure Vessel Code (BPVC) | 2013

# Heating Boilers – Product Certification Packages

**H Designator:**  
Cast Iron Section Heating Boilers

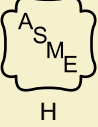

**Code Books Required:**  
BPVC-IV – Section IV, Heating Boilers

**ORDER NO. BPVCH2**

**H Designator:**  
Field Assembly of Boilers

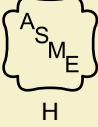

**Code Books Required:**  
BPVC-IV – Section IV, Heating Boilers  
BPVC-IX – Section IX, Welding and Brazing Qualifications

**ORDER NO. BPVCH**

**H Designator :**  
Heating Boilers, Except Cast Iron

**HLW Designator :**  
Lined Potable Water Heaters

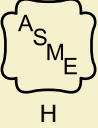

**Code Books Required:**  
BPVC-II – Section II, Materials  
Part A – Ferrous Materials Specifications  
Part B – Nonferrous Materials Specifications  
Part C – Specifications for Welding Rods, Electrodes and Filler Metals

BPVC-IV – Section IV, Heating Boilers  
BPVC-IX – Section IX, Welding and Brazing Qualifications

**ORDER NO. BPHLW**

**HV Designator :**  
Heating Boiler Safety Valves



**Code Books Required:**  
BPVC-II – Section II, Materials  
Part A – Ferrous Materials Specifications  
Part B – Nonferrous Materials Specifications  
Part C – Specifications for Welding Rods, Electrodes and Filler Metals

BPVC-IV – Section IV, Heating Boilers  
BPVC-IX – Section IX, Welding and Brazing Qualifications  
PTC-25 – Pressure Relief Devices

**ORDER NO. BPVHV**

# Pressure Vessels

## Section VIII – Pressure Vessels

Division 1 provides requirements applicable to the design, fabrication, inspection, testing, and certification of pressure vessels operating at either internal or external pressures exceeding 15 psig. Such vessels may be fired or unfired. This pressure may be obtained from an external source or by the application of heat from a direct or indirect source, or any combination thereof. Specific requirements apply to several classes of material used in pressure vessel construction, and also to fabrication methods such as welding, forging and brazing.

Division 1 contains mandatory and non-mandatory appendices detailing supplementary design criteria, nondestructive examination and inspection acceptance standards. Rules pertaining to the use of the single ASME certification mark with the U, UM and UV designators are also included.

Division 2 requirements on materials, design, and nondestructive examination are more rigorous than in Division 1; however, higher design stress intensify values are permitted. These rules may also apply to human occupancy pressure vessels typically in the diving industry. Rules pertaining to the use of the single ASME certification mark with the U2 and UV designators are also included.

Division 3 requirements are applicable to pressure vessels operating at either internal or external pressures generally above 10,000 psi. It does not establish maximum pressure limits for either Section VIII, Divisions 1 or 2, nor minimum pressure limits for this Division. Rules pertaining to the use of the single ASME certification mark with the U3 and UV3 designator are also included.

## Referenced BPVC Sections

### BPVC-II, A, B, C, D --

Section II, Materials, Parts A through D

### BPVC-V --

Section V, Nondestructive Examination

### BPVC-IX --

Section IX, Welding and Brazing Qualifications

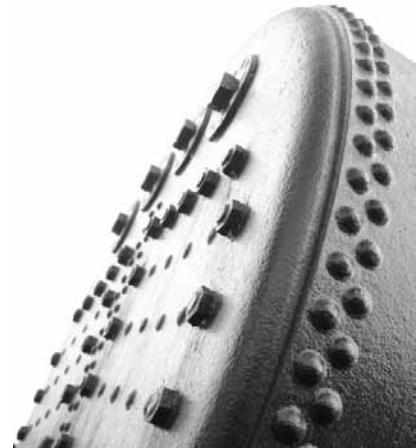

This is a preview of "BPVC-VII-2013". [Click here to purchase the full version from the ANSI store.](#)



# Pressure Vessels, continued

## Referenced ASME Standards

### Division 1:

Five Standards from the B1 Series on screw threads

Thirteen Standards from the B16 Series on pipe flanges and fittings

Nine Standards from the B18 Series on hex bolts

### B36.10M --

Welded and Seamless Wrought Steel Pipe

### B36.19M --

Stainless Steel Pipe

### NQA-1 --

Quality Assurance Program Requirements for Nuclear Facilities

### PCC-1 --

Guidelines for Pressure Boundary Bolted Flange Joint Assembly

### PCC-2 --

Repair of Pressure Equipment and Piping

### PTC 25 --

Pressure Relief Devices

### QAI-1 --

Qualifications for Authorized Inspection

### Division 2:

#### API 579-1/ASME FFS-1 --

Fitness-For-Service

Three Standards from the B1 Series on screw threads

Nine Standards from the B16 Series on pipe flanges and fittings

Four Standards from the B18 Series on hex bolts

### B36.10M --

Welded and Seamless Wrought Steel Pipe

### B36.19M --

Stainless Steel Pipe

### NQA-1 --

Quality Assurance Program Requirements for Nuclear Facilities

### PCC-1 --

Guidelines for Pressure Boundary Bolted Flange Joint Assembly

### PTC 25 --

Pressure Relief Devices

### QAI-1 --

Qualifications for Authorized Inspection

### Division 3:

#### API 579-1/ASME FFS-1 --

Fitness-For-Service

Three Standards from the B1 Series on screw threads

Four Standards from the B16 Series on pipe flanges and fittings

Seven Standards from the B18 Series on hex bolts

### B36.10M --

Welded and Seamless Wrought Steel Pipe

### B46.1 --

Surface Texture (Surface Roughness, Waviness and Lay)

### PTC 25 --

Pressure Relief Devices

### QAI-1 --

Qualifications for Authorized Inspection

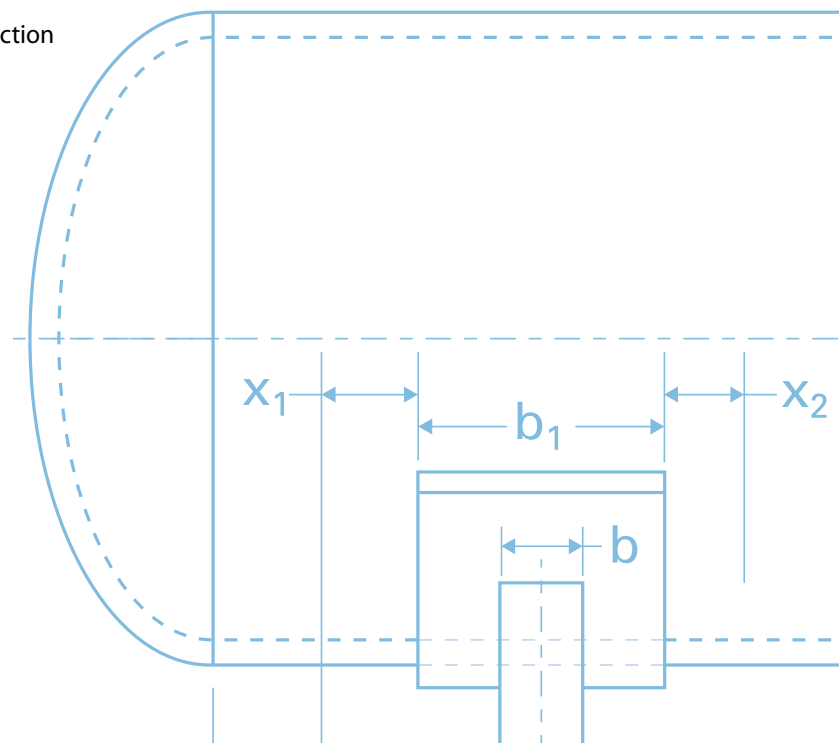

# Pressure Vessels – Product Certification Packages

## Product Certification Packages -- All

### UV Designator:

Pressure Vessels Safety Valves



### Code Books Required:

**BPVC-II – Section II, Materials**

Part A – Ferrous Materials Specifications

Part B – Nonferrous Materials Specifications

Part C – Specifications for Welding Rods, Electrodes and Filler Metals

Part D – Properties (Customary or Metric)

**BPVC-VIII – Section VIII, Pressure Vessels, Division 1 or Division 2**

**BPVC-IX – Section IX, Welding and Brazing Qualifications**

**PTC-25 – Pressure Relief Devices**

### ORDER NO. BPUV1

Includes BPVC-VIII-1 – Section VIII, Pressure Vessels, Division 1

### ORDER NO. BPUV2

Includes BPVC-VIII-2 – Section VIII, Pressure Vessels, Division 2

## Product Certification Packages – Div 1

### U Designator:

Pressure Vessels, Division 1

### UM Designator :

Miniature Pressure Vessels



### Code Books Required:

**BPVC-II – Section II, Materials**

Part A – Ferrous Materials Specifications

Part B – Nonferrous Materials Specifications

Part C – Specifications for Welding Rods, Electrodes and Filler Metals

Part D – Properties (Customary or Metric)

**BPVC-V – Section V, Nondestructive Examination**

**BPVC-VIII-1 – Section VIII, Pressure Vessels, Division 1**

**BPVC-IX – Section IX, Welding and Brazing Qualifications**

### ORDER NO. BPVUM

### UD Designator:

Rupture Disc Devices



### Code Books Required:

**BPVC-II – Section II, Materials**

Part A – Ferrous Materials Specifications

Part B – Nonferrous Materials Specifications

Part C – Specifications for Welding Rods, Electrodes and Filler Metals

Part D – Properties (Customary or Metric)

**BPVC-VIII-1 – Section VIII, Pressure Vessels, Division 1**

**BPVC-IX – Section IX, Welding and Brazing Qualifications**

**PTC-25 – Pressure Relief Devices**

### ORDER NO. BPVCUD

## Product Certification Packages – Div 2

### U2 Designator:

Pressure Vessels, Division 2



### Code Books Required:

**BPVC-II – Section II, Materials**

Part A – Ferrous Materials Specifications

Part B – Nonferrous Materials Specifications

Part C – Specifications for Welding Rods, Electrodes and Filler Metals

Part D – Properties (Customary or Metric)

**BPVC-V – Section V, Nondestructive Examination**

**BPVC-VIII-2 – Section VIII, Pressure Vessels, Division 2 - Alternate Rules**

**BPVC-IX – Section IX, Welding and Brazing Qualifications**

### ORDER NO. BPVU1

## Product Certification Packages – Div 3

### UV3 Designator:

Pressure Vessels Safety Valves

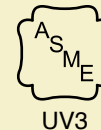

### Code Books Required:

**BPVC-II – Section II, Materials**

Part A – Ferrous Materials Specifications

Part B – Nonferrous Materials Specifications

Part C – Specifications for Welding Rods, Electrodes and Filler Metals

Part D – Properties (Customary or Metric)

**BPVC-VIII-3 – Section VIII, Pressure Vessels, Division 3**

**BPVC-IX – Section IX, Welding and Brazing Qualifications**

**PTC 25 – Pressure Relief Devices**

### ORDER NO. BPUV3

### U3 Designator:

Pressure Vessels, Division 3



### Code Books Required:

**BPVC-II – Section II, Materials**

Part A – Ferrous Materials Specifications

Part B – Nonferrous Materials Specifications

Part C – Specifications for Welding Rods, Electrodes and Filler Metals

Part D – Properties (Customary or Metric)

**BPVC-V – Section V, Nondestructive Examination**

**BPVC-VIII-3 – Section VIII, Pressure Vessels, Division 3 – Alternative Rules**

**BPVC-IX – Section IX, Welding and Brazing Qualifications**

### ORDER NO. BPVU3

# Transport Tanks

## Section XII – Transport Tanks

Provides requirements for construction and continued service of pressure vessels for the transportation of dangerous goods via highway, rail, air or water at pressures from full vacuum to 3,000 psig and volumes greater than 120 gallons. "Construction" is an all-inclusive term comprising materials, design, fabrication, examination, inspection, testing, certification, and over-pressure protection. "Continued service" refers to inspection, testing, repair, alteration, and recertification of a transport tank that has been in service. Rules pertaining to the use of the single ASME certification mark with the T, TD, and TV designators are included.

## Referenced BPVC Sections

- BPVC-II, A, B, C, D --**  
Section II, Materials, Parts A through D
- BPVC-V --**  
Section V, Nondestructive Examination
- BPVC-VIII-1-2 --**  
Section VIII, Pressure Vessels, Division 1 and Division 2
- BPVC-IX --**  
Section IX, Welding and Brazing Qualifications

## Referenced ASME Standards

- B1.1 --**  
Unified Inch Screw Threads (UN and UNR Thread Form)
- B1.20.1 --**  
Pipe Threads, General Purpose, Inch
- Nine Standards from the B16 Series on pipe flanges and fittings
- B18.2.2 --**  
Square and Hex Nuts
- B36.10M --**  
Welded and Seamless Wrought Steel Pipe
- PTC 25 --**  
Pressure Relief Devices
- QAI-1 --**  
Qualifications for Authorized Inspection

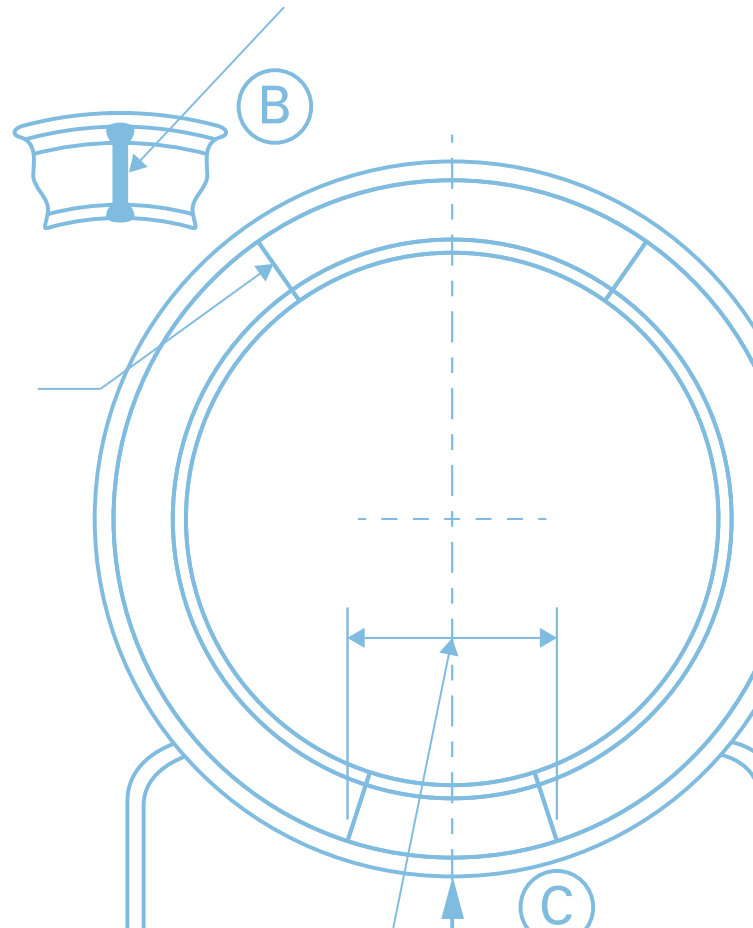

# Transport Tanks – Product Certification Packages

**T Designator:**

Transport Tanks



**Code Books Required:**

**BPVC-II – Section II, Materials**

Part A – Ferrous Materials Specifications

Part B – Nonferrous Materials Specifications

Part C – Specifications for Welding Rods, Electrodes and Filler Metals

Part D – Properties (Customary or Metric)

**BPVC-V – Section V, Nondestructive Examination**

**BPVC-IX – Section IX, Welding and Brazing Qualifications**

**BPVC-XII – Section XII, Transport Tanks**

**ORDER NO. BPVCT**

**TD Designator:**

Transport Tanks Rupture Disk Devices

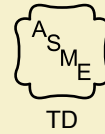

**Code Books Required:**

**BPVC-II – Section II, Materials**

Part A – Ferrous Materials Specifications

Part B – Nonferrous Materials Specifications

Part C – Specifications for Welding Rods, Electrodes and Filler Metals

Part D – Properties (Customary or Metric)

**BPVC-IX – Section IX, Welding and Brazing Qualifications**

**BPVC-XII – Section XII, Transport Tanks**

**PTC-25 – Pressure Relief Devices**

**ORDER NO. BPVCTD**

**TV Designator:**

Transport Tanks Safety Valves



**Code Books Required:**

**BPVC-II – Section II, Materials**

Part A – Ferrous Materials Specifications

Part B – Nonferrous Materials Specifications

Part C – Specifications for Welding Rods, Electrodes and Filler Metals

Part D – Properties (Customary or Metric)

**BPVC-IX – Section IX, Welding and Brazing Qualifications**

**BPVC-XII – Section XII, Transport Tanks**

**PTC-25 – Pressure Relief Devices**

**ORDER NO. BPVCTV**

ASME's Boiler and Pressure Vessel Code (BPVC) | 2013

# Fiber-Reinforced Pressure Vessels

## Section X – Fiber-Reinforced Pressure Vessels

Provides requirements for construction of a fiber-reinforced pressure vessel (FRP) in conformance with a manufacturer's design report. It includes production, processing, fabrication, inspection and testing methods required for the vessel. Section X includes three Classes of vessel design: Class I and Class III - qualification through the destructive test of a prototype; and Class II - mandatory design rules and acceptance testing by nondestructive methods. These vessels are not permitted to store, handle or process lethal fluids. Vessel fabrication is limited to the following processes: bag-molding, centrifugal casting and filament-winding and contact molding. Rules pertaining to the use of the single ASME certification mark with the RP designator are also included.

## Referenced BPVC Sections

**BPVC-V –**  
Nondestructive Examination

## Referenced ASME Standards

**B16.1 --**  
Gray Iron Pipe Flanges and Flanged Fittings: Classes 25, 125, and 250

**B16.5 --**  
Pipe Flanges and Flanged Fittings: NPS 1/2 through NPS 24 Metric/Inch Standard

**B18.22.1 --**  
Plain Washers

## Product Certification Packages

**RP Designator:**  
Fiber-Reinforced Plastic Vessels



**Code Books Required:**  
BPVC-X – Section X, Fiber-Reinforced Plastic Vessels

**ORDER NO. BPVRP**

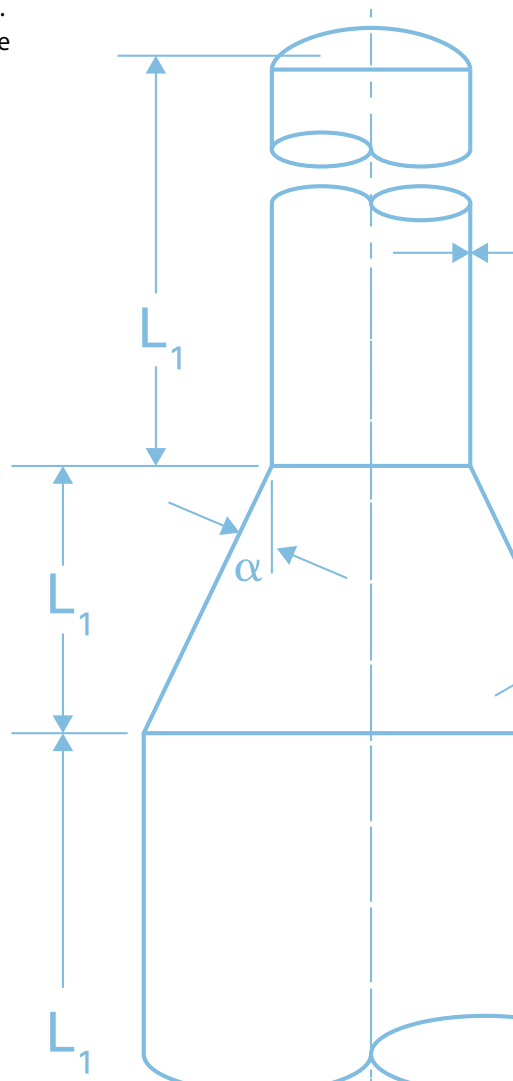

This is a preview of "BPVC-VII-2013". [Click here to purchase the full version from the ANSI store.](#)



# Construction of Nuclear Facility Components

## Section III – Rules for Construction of Nuclear Facility Components

Provides general requirements which address the material, design, fabrication, examination, testing and overpressure protection of the items specified within each respective Subsection, assuring their structural integrity.

### Division 1, Subsection NCA

Subsection NCA, which is referenced by and is an integral part of Division 1, Subsections NB through NG, and Division 2 of Section III, covers quality assurance requirements, ASME product-certification marks, and authorized inspection for Class 1, 2, 3, MC, CS, and CC construction.

### Division 1, Subsections NB, NF, APP

Subsection NB addresses items which are intended to conform to the requirements for Class 1 construction.

Subsection NF addresses supports which are intended to conform to the requirements for Classes 1, 2, 3, and MC construction.

Subsection APP contains appendices, both mandatory and non-mandatory for Section III, Division 1 (Subsections NCA through NG), Division 2 and Division 3, including a listing of design and design analysis methods and information, plus Data Report Forms. These appendices are referenced by, and are an integral part of, Subsections NCA through NG, Division 2 and Division 3.

### Division 1, Subsections NC, ND

Subsection NC addresses items which are intended to conform to the requirements for Class 2 construction.

Subsection ND addresses items which are intended to conform to the requirements for Class 3 construction.

### Other Subsections and Divisions

Subsection NE addresses items which are intended to conform to the requirements for Class MC construction.

Subsection NF addresses the supports which are intended to conform to the requirements for Classes 1, 2, 3, and MC construction.

Subsection NG addresses structures which are designed to provide direct support or restraint of the core (fuel & blanket assemblies) within the reactor pressure vessel.

Subsection NH addresses Class 1 components, parts, and appurtenances which are expected to function even when metal temperatures exceed those covered by the rules and stress limits of Subsection NB and Tables 2A, 2B, and 4 of Section II, Part D, Subpart 1.

Division 2 addresses concrete containment structures, pre-stressed or reinforced. These requirements are applicable only to those components that are designed to provide a pressure retaining or containing barrier.

Division 3 addresses the design and construction of the containment system of a nuclear spent fuel or high level radioactive waste transport packaging.

The all-new Division 5 provides construction rules for high-temperature reactors, including both high-temperature, gas-cooled reactors (HTGRs) and liquid-metal reactors (LMRs).

## Referenced BPVC Sections

### BPVC-II, A, B, C, D --

Section II, Materials, Parts A through D

### BPVC-V --

Section V, Nondestructive Examination

### BPVC-IX --

Section IX, Welding and Brazing Qualifications

### BPVC-XI --

Section XI, Rules for Inservice Inspection of Nuclear Power Plant Components

## Referenced ASME Standards

Three Standards from the B1 Series on screw threads

Eight Standards from the B16 Series on pipe flanges and fittings

Three Standards from the B18 Series on hex bolts

### B36.10M --

Welded and Seamless Wrought Steel Pipe

### B36.19M --

Stainless Steel Pipe

### NQA-1 --

Quality Assurance Program Requirements for Nuclear Facilities

### QAI-1 --

Qualifications for Authorized Inspection

# Nuclear Construction – Product Certification Packages

## N Designators:

N-Type Certificates of Authorization and Certificates of Accreditation: N, NA, NPT, NS



### Code Books Required:

#### BPVC-II – Section II, Materials

Part D – Properties (N and NA only)  
(Customary or Metric)

#### BPVC-III – Section III, Construction of Nuclear Facility Components

Subsection NCA – General Requirements for Division 1 and Division 2 (not required for Division 3); Appendices

#### BPVC-V – Section V, Nondestructive Examination

#### BPVC-IX – Section IX, Welding and Brazing Qualifications

#### NQA-1 – Quality Assurance for Nuclear Facilities

### ORDER NO. BPNPT

Applicants should note that they may need one or more of the following parts of Section II and Subsections of Section III, depending on the scope of their work, to appear on the certificate:

#### BPVC-II – Section II, Materials

Part A – Ferrous Materials Specifications

Part B – Nonferrous Materials Specifications

Part C – Specifications for Welding Rods, Electrodes and Filler Metals

Part D – Properties (N and NA Only)  
(Customary or Metric)

#### BPVC-III – Section III, Construction of Nuclear Facility Components

Subsection NB – Class 1 Components

Subsection NC – Class 2 Components

Subsection ND – Class 3 Components

Subsection NE – Class MC Components

Subsection NF – Supports

Subsection NG – Core Supports

Subsection NH – Class 1 Components in Elevated Temperature Service

#### Division 2 – Concrete Reactor Vessels and Containments

#### Division 3 – Containment Systems for Storage and Transport Packaging of Spent Nuclear Fuel and High Level Radioactive Materials and Waste

## NV Designator:

Nuclear Safety and Pressure Relief Valves



### Code Books Required:

#### BPVC-III – Section III, Construction of Nuclear Facility Components

Subsection NCA – General Requirements for Division 1 and Division 2; Appendices

#### BPVC-II – Section II, Materials

Part A – Ferrous Materials Specifications

Part B – Nonferrous Materials Specifications

Part D – Properties (Customary or Metric)

#### BPVC-V – Section V, Nondestructive Examination

#### BPVC-IX – Section IX, Welding and Brazing Qualifications

#### NQA-1 – Quality Assurance for Nuclear Facilities

#### PTC-25 – Pressure Relief Devices

### ORDER NO. BPNVA (w/ Section II, Part A)

### ORDER NO. BPNVB (w/ Section II, Part B)

### ORDER NO. BPNVD (w/ Section II, Part D)

Applicants should note that they may need one or more of the following Subsections of Section III, depending on the scope of their work, to appear on the certificate:

#### BPVC-III – Section III, Construction of Nuclear Facility Components

Subsection NB – Class 1 Components

Subsection NC – Class 2 Components

Subsection ND – Class 3 Components

Subsection NH – Class 1 Components in Elevated Temperature Service

## N3 Designator:

N-Type Certificates of Authorization and Certificates of Accreditation: N3

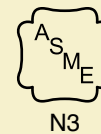

### Code Books Required:

#### BPVC-II – Section II, Materials

Part D – Properties (Customary or Metric)

#### BPVC-III – Section III, Construction of Nuclear Facility Components

Division 3 – Containment Systems for Storage and Transport Packaging of Spent Nuclear Fuel and High Level Radioactive Material and Waste

#### BPVC-V – Section V, Nondestructive Examination

#### BPVC-IX – Section IX, Welding and Brazing Qualifications

#### NQA-1 – Quality Assurance for Nuclear Facilities

### ORDER NO. PVCN3

Applicants should note that they may need one or more of the following parts of Section II and Subsections of Section III, depending on the scope of their work, to appear on the certificate:

#### BPVC-II – Section II, Materials

Part A – Ferrous Materials Specifications

Part B – Nonferrous Materials Specifications

Part C – Specifications for Welding Rods, Electrodes and Filler Metals

Part D – Properties (N and NA Only)  
(Customary or Metric)

#### BPVC-III – Section III, Construction of Nuclear Facility Components

Subsection NB – Class 1 Components

Subsection NC – Class 2 Components

Subsection ND – Class 3 Components

Subsection NE – Class MC Components

Subsection NF – Supports

Subsection NG – Core Supports

Subsection NH – Class 1 Components in Elevated Temperature Service

Division 2 – Concrete Reactor Vessels and Containments

Subsection NCA – General Requirements for Division 1 and Division 2; Appendices

# Nuclear Inservice

## Section XI – Rules for Inservice Inspection of Nuclear Power Plant Components

Contains Divisions 1 and 3, in one volume, and provides rules for the examination, inservice testing and inspection, and repair and replacement of components and systems in light water cooled and liquid metal cooled nuclear power plants. Application of Section XI begins when the requirements of the "construction code" (e.g., Section III) have been satisfied.

Section XI constitutes requirements to maintain the nuclear power plant while in operation and to return the plant to service, following plant outages, and repair or replacement activities. These rules require a mandatory program of scheduled examinations, testing, and inspections to evidence adequate safety. The method of nondestructive examination to be used and flaw size characterization are also contained within this Section.

## Referenced BPVC Sections

- BPVC-II, A, B, C, D --**  
Section II, Materials, Parts A through D
- BPVC-III --**  
Section III, Rules for Construction of Nuclear Facility Components:
  - Subsection NCA, General Requirements for Division 1 and Division 2
  - Subsection NB, Class 1 Components
  - Subsection NC, Class 2 Component
  - Subsection ND, Class 3 Components
  - Subsection NE, Class MC Components
  - Subsection NF, Supports
  - Subsection NG, Core Support Structures
  - Subsection NH, Class 1 Components in Elevated Temperature Service
- Appendices
- Division 2-Code for Concrete Containments
- Division 3-Containments for Transportation & Storage of Spent Nuclear Fuel and High Level Radioactive Material & Waste
- Division 5, High Temperature Reactors
- BPVC-V --**  
Section V, Nondestructive Examination
- BPVC-VIII-1-2 --**  
Section VIII, Pressure Vessels, Division 1 and Division 2
- BPVC-IX --**  
Section IX, Welding and Brazing Qualifications

## Referenced ASME Standards

- NQA-1 --**  
Quality Assurance Requirements for Nuclear Facilities Applications (QA)
- QAI-1 --**  
Qualifications for Authorized Inspection
- RA-S --**  
Standard for Level 1 / Large Early Release Frequency Probabilistic Risk Assessment for Nuclear Power Plant Applications

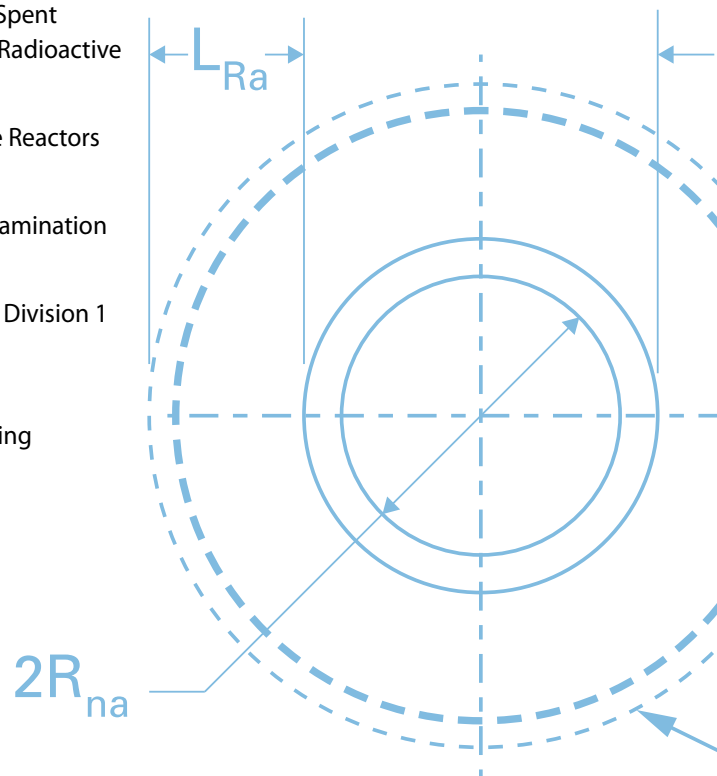

# Nuclear Inservice – Product Certification Packages

## Quality Systems Certificates –

Material Manufacturers,  
Materials Suppliers



### Code Books Required:

#### BPVC-II – Section II, Materials

Part A – Ferrous Materials Specifications

Part B – Nonferrous Materials  
Specifications

Part C – Specifications for Welding Rods,  
Electrodes and Filler Metals

Part D – Properties (N and NA Only)  
(Customary or Metric)

#### BPVC-III – Section III, Construction of Nuclear Facility Components

Subsection NCA – General Requirements  
for Division 1 and Division 2; Appendices

#### BPVC-V – Section V, Nondestructive Examination

#### BPVC-IX – Section IX, Welding and Brazing Qualifications

#### NQA-1 – Quality Assurance for Nuclear Facilities

**ORDER NO. (Contact ASME)**

Applicants should note that they may need one or more of the following parts of Section III, depending on the scope of their work, to appear on the certificate. In addition, these Subsection contain material requirements on Section 2000, which reference Section V and Section IX.

#### BPVC-III -- Section III, Construction of Nuclear Facility Components

Subsection NB – Class 1 Components

Subsection NC – Class 2 Components

Subsection ND – Class 3 Components

Subsection NE – Class MC Components

Subsection NF – Supports

Subsection NG – Core Supports

Subsection NH – Class 1 Components in  
Elevated Temperature Service

#### BPVC-V – Section V, Nondestructive Examination

#### BPVC-IX – Section IX, Welding and Brazing Qualifications

## Service Sections

### Section II – Materials

Part A covers Ferrous Material; Part B covers Nonferrous Material; Part C covers Welding Rods, Electrodes, and Filler Metals; and Part D covers Material Properties in both Customary and Metric units of measure.

Together, these four parts of Section II comprise a “service Code” to other BPVC Sections, providing material specifications adequate for safety in the field of pressure equipment. These specifications contain requirements for chemical and mechanical properties, heat treatment, manufacture, heat and product analyses, and methods of testing. Part A and Part B specifications are designated by SA or SB numbers, respectively, and are identical with or similar to those of specifications published by ASTM and other recognized national or international organizations. Part C specifications are designated by SFA numbers and are derived from AWS specifications.

### Section V – Nondestructive Examination

Is another “service Code” – containing requirements and methods for nondestructive examination which are referenced and required by other BPVC Sections. It also includes manufacturer’s examination responsibilities, duties of authorized inspectors and requirements for qualification of personnel, inspection and examination. Examination methods are intended to detect surface and internal discontinuities in materials, welds, and fabricated parts and components. A glossary of related terms is included.

### Section IX – Welding and Brazing Qualifications

Is another “service Code” -- containing rules relating to the qualification of welding and brazing procedures as required by other BPVC Sections. It also covers rules relating to the qualification and requalification of welders, brazers, and welding and brazing operators in order that they may perform welding or brazing in component manufacture. Welding and brazing data cover essential and nonessential variables specific to the welding or brazing process used.

### Code Cases – Pressure Technology / Nuclear

Historically, the BPVC has been revised every three years; beginning with the 2013 Edition, it will be revised every two years. But what happens in the interim with new materials or alternative constructions? How does the BPVC keep current with the latest in technology and applications?

Code Cases are approved actions by the BPVC Committees on these alternatives, intended to allow early and urgent implementation of any revised requirements. They are issued four times per year in two categories: Boiler and Pressure Vessels (CC-BPV) and Nuclear (CC-NUC). Users may purchase individual publications at any time. Or they may subscribe to receive full sets of Code Cases as they are published for the duration of that BPVC edition’s cycle.

This responsiveness to requests illustrates the unique openness and transparency of ASME’s code-development process – striving to reflect best-practices of industry, while contributing to safety for the general public.

### NQA-1 -- Quality Assurance Requirements for Nuclear Facility Applications (QA)

Provides requirements and guidelines for the establishment and execution of quality assurance programs during siting, design, construction, operation and decommissioning of nuclear facilities. This Standard reflects industry experience and current understanding of the quality assurance requirements necessary to achieve safe, reliable, and efficient utilization of nuclear energy, and management and processing of radioactive materials.

NQA-1 focuses on the achievement of results, and emphasizes the role of the individual and line management in the achievement of quality. It fosters the application of these requirements in a manner consistent with the relative importance of the item or activity.

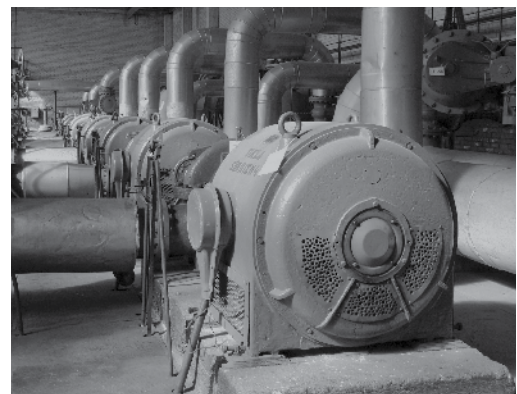

This is a preview of "BPVC-VII-2013". Click [here](#) to purchase the full version from the ANSI store.



This is a preview of "BPVC-VII-2013". Click [here](#) to purchase the full version from the ANSI store.

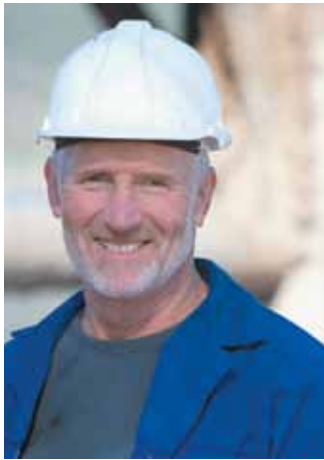

# Volunteering

## Benefits of Volunteering for BPVC Committees

For more than 100 years, ASME has successfully attracted volunteer technical experts to develop, maintain and disseminate ASME codes and standards. Participation by volunteers is the lifeblood of the BPVC. BPVC Committee participation provides value to the individuals involved, their employers that provide the funding for participation, and the general public.

### Individuals:

As a BPVC Committee volunteer, you gain:

- Technical interaction and collaboration with the foremost experts in your field
- Creation of a personal network of contacts for valuable technical advice
- Pride in doing something important for your profession
- Opportunities to have one's work incorporated into a globally-recognized Code
- Knowledge that you're making a positive impact on your career

### Companies:

Involvement on BPVC committees provides companies with critical information, plus opportunities to expand their global networks and strengthen involvement in the decision-making process.

Being involved in the development of codes and standards provides early and ongoing awareness of technical issues in industry and how others are dealing with them. This awareness allows participants to avoid these issues within their own organizations or to have solutions prepared should problems arise.

### Government:

ASME also helps governments ensure the safety of their citizens and their environment through the adoption of codes and standards to satisfy regulation. Use of codes and standards lessens the burden on government by providing a technically-sound basis for achieving regulatory goals without imposing an unnecessary burden on industry. Government involvement on BPVC committees provides officials with critical information and strengthens involvement in the decision-making process, so that regulations are understood and enforceable.

## "Boiler Code Weeks" / C&S Connect

The BPVC is kept current by the BPVC Committee, a volunteer group of nearly 1,000 technical experts, balanced between the interests of industry, government and R&D. The Committee meets in person four times per year during "Boiler Code Weeks" to consider requests for interpretations,

revisions, and to develop new rules. Its activities culminate in a new edition of the BPVC, now issued and published every two years.

In the formation of its rules and the establishment of maximum design and operating pressures, the Committee considers technological advances including materials, construction, methods of fabrication, inspection, certification, and overpressure protection. It functions in a fully open and transparent manner via consensus process. The results of this methodology have resulted in codes and standards proven safe, reliable and effective worldwide, across dozens of major industries, for more than a century.

Committee communications, including balloting, takes place throughout the year using ASME's award-winning electronic system, "C&S Connect." International members have especially appreciated the convenience and flexibility afforded by these "24/7/365" means, which has led to international membership on the Committee increasing in recent years to over 10%.

The Committee benefits from a broad range of volunteer experience, from department heads and the top technical experts in their fields all the way to young engineers in their early-career stages. This mix helps assure that the resulting standards are truly visionary, while also being practical and applicable for everyday end-users. All those interested are welcome to apply.

Visit [go.asme.org/ParticipateInStandards](http://go.asme.org/ParticipateInStandards).



ASME's Boiler and Pressure Vessel Code (BPVC) | 2013

## New Programs

### NQA-1 Product Certification

ASME's NQA-1 Certification is a new program for organizations supplying items or services that provide a safety function for nuclear facilities... to have their Quality Assurance (QA) programs recognized by ASME as being in conformance with the requirements of the ASME NQA-1 Standard.

ASME's NQA-1 Certification will provide independent, third-party, centralized certification for QA programs as an option to the various other programs currently in effect. It offers particular value to new organizations with items or services relevant to the nuclear industry, and to jurisdictions without their own certification programs. Thus ASME's NQA-1 Certification will help to standardize certification for nuclear QA worldwide.

Visit [go.asme.org/NQA-1](http://go.asme.org/NQA-1).

### CA Connect

In 2011, ASME successfully debuted a new online system to process its product certifications: "CA Connect." Custom-designed in joint venture with Microsoft Corp., CA Connect promises superior customer service to ASME's thousands of product-certificate holders and applicants worldwide.

Key features include: streamlined applications; speedier responses from ASME; real-time status for all aspects of your application, including reviews, change requests, invoices and scheduling; automated notifications and communications.

For more information, email to [ca@asme.org](mailto:ca@asme.org).

### ANDE Personnel Certification

ANDE is a new certification program for Non-Destructive Examination (NDE) personnel and quality control (QC) inspectors. It will comply with the applicable requirements of the ASME NQA-1 Standard for the qualification and certification of NDE personnel. ANDE will also comply with ANSI N45.2.6 and NQA-1 for the qualification and certification of QC Inspectors.

ANDE will provide independent, third-party, centralized certification for NDE & QC inspection personnel as an option to the historical, employer-based NDE & QC certification systems. Thus it will help to standardize workforce development for nuclear NDE & QC worldwide by offering transportable certification credentials.

Visit [go.asme.org/ANDE](http://go.asme.org/ANDE).

### ASME "S&C Update" eNewsletter

ASME's "S&C Update" is a new, quarterly eNewsletter designed to keep interested parties up-to-date on ASME Standards & Certification activities. It covers "What's New" in general; sections on ASME Standards and other publications; and focus on "Global Outreach," "Energy Spotlight," "Training & Development" and "Calendar of Events." There are also periodic features on key ASME personnel and volunteers, plus topics of mutual interest.

For a no-obligation subscription, email to [S&CNewsletter@asme.org](mailto:S&CNewsletter@asme.org).

## Current Programs

### Product Certifications

ASME Product Certification programs -- under which a company is assessed and certified based on demonstrated ability to meet the requirements of an ASME standard -- continue to provide a vital service to enhancement of public safety and facilitation of international commerce.

For 100 years, the strength of ASME standards and related product certifications is that they form an interlocking system based on having a set of requirements developed through an open and transparent consensus process. They may involve independent, third-party inspection during the process, uniform qualification of inspectors, and acceptance by government entities. It is the common understanding and confidence and trust in this system, that has enabled regulated equipment built in one jurisdiction to be readily accepted for installation in another.

In 2010, ASME reached a milestone of certifying more than 6,000 manufacturers in 75 nations.

*Visit [go.asme.org/certification-accreditation](http://go.asme.org/certification-accreditation).*

### Personnel Certifications

Over 5,000 professionals throughout North America have achieved these respected credentials for themselves, while bringing

back to their sponsoring organizations best-practices for improving operational safety and efficiency. ASME Personnel Certification programs include:

- QRO – Certification for Municipal Solid Waste Combustion Facilities Operators
- QFO - Certification of High Capacity Fossil Fuel Fired Plant (Boiler) Operators
- GDTP (Y14.5) – Geometric Dimensioning and Tolerancing Professional Certification

Under Development:

- ANDE - ASME Nondestructive Examination (NDE) and Quality Control (QC) Inspection Personnel Certification
- NQA Auditors – Certification and certification of individuals to perform audits to NQA-1 requirements

*Visit [go.asme.org/personnel-certification](http://go.asme.org/personnel-certification).*

### ASME Standards Technology, LLC

ASME Standards Technology, LLC was established in 2004 as a separate not-for-profit organization, with the mission of providing ASME's codes and standards committees with the technical basis necessary to develop new codes and standards for emerging technologies. The ultimate adoption of relevant consensus standards for emerging technologies, helps overcome barriers to commercialization by establishing public and regulatory confidence, permitting rapid and transportable workforce development, removing impediments to business, and enabling global trade. ASME ST-LLC provides market-relevant technical products and services by partnering with public and private entities.

*Visit [go.asme.org/STLLC](http://go.asme.org/STLLC).*

### Training and Development Courses

As a recognized leader in workforce learning solutions, ASME helps individuals expand their knowledge and organizations develop their core assets -- boosting technical competence and heightening managerial expertise. All ASME Training & Development programs are delivered by ASME-approved instructors who are recognized experts within their professional disciplines. Importantly, most codes and standards courses are taught by ASME Code Committee members who understand and can communicate code or standard relevance and its impact on safety, quality and integrity.

ASME Training and Development's more than 200 courses are offered in multiple formats: public courses, eLearning courses, seminars and workshops, plus in-company training, which may be customized to individual company requirements.

*Visit [go.asme.org/education](http://go.asme.org/education)*

ASME's Boiler and Pressure Vessel Code (BPVC) | 2013

## Conferences and Publications

### Conferences and Publications

ASME's conferences and publications are primary vehicles for disseminating technical information to the engineering community. The Society's preeminent technical conference is the annual International Mechanical Engineering Congress and Exposition, which brings together many of the Society's technical divisions and volunteer leaders to discuss the state of the art in engineering and technology.

The Society sponsors many other technical conferences and events throughout the year, including:

- ASME Turbo Expo: Power for Land, Sea and Air
- ASME Pressure Vessels and Piping Conference (PVP)
- ASME Power Conference (Power)
- International Conference on Nuclear Engineering (ICONE)
- ASME Small Modular Reactors Symposium (SMR)
- International Heat Transfer Conference
- International Pipeline Conference (IPC)
- Offshore Technology Conference (OTC)

Visit [www.asme.org/events](http://www.asme.org/events).

Conference proceedings comprise one arm of the Society's extensive and internationally-recognized publishing operation that also encompasses codes and standards, engineering manuals and academic texts under the ASME Press imprint, plus technical journals in a variety of disciplines. Popular journals of the Society include:

- Journal of Pressure Vessel Technology
- Journal of Engineering for Gas Turbines and Power
- Journal of Turbomachinery
- Journal of Heat Transfer
- Journal of Manufacturing Science and Engineering

ASME's technical publications are available in print or electronically via the ASME Digital Collection, a powerful online tool that allows cross-journal searching, extensive links to primary publishers and databases, and a complete suite of personalization tools.

ASME also publishes *Mechanical Engineering magazine*, *Mechanical Advantage*, *ME Today*, and *ASME News*, the Society's online newspaper.

Visit [www.asme.org/publications](http://www.asme.org/publications).



This is a preview of "BPVC-VII-2013". [Click here to purchase the full version from the ANSI store.](#)



This is a preview of "BPVC-VII-2013". Click here to purchase the full version from the ANSI store.



Two Park Avenue  
New York, NY  
10016-5990 U.S.A.

U.S. Postage  
PAID  
Permit No. 121  
N. Reading, MA

## 2013 ASME Boiler and Pressure Vessel Code An International Code

[www.go.asme.org/bpvc13](http://www.go.asme.org/bpvc13)

## ASME guides you through the BPVC...

This fourth edition of the "Companion Guide" to ASME's legendary Boiler and Pressure Vessel Code (BPVC) has been updated to the current (2010) Edition and (2011) Addenda. Edited by K.R. Rao, it contains 38 chapters authored by 49 technical experts, who have considerably updated and extensively re-written chapters, as well as provided entirely new chapters. Unlike the third edition, this fully updated and revised fourth edition is now in a convenient, two-volume format. It is a classic reference work focusing on all 12 Sections of the BPVC, as well as the relevant Piping Codes and Standards.

The first two volumes covering BPVC Sections I through XII consider the dramatic changes in the industry, state-of-the-art of technology, and regulatory practices. Organizational changes of the Boiler and Pressure Vessel Committees are included in the front matter of both volumes. A unique feature of this publication is the inclusion of all author biographies and an introduction that synthesizes every chapter, along with an extensive index, which includes more than 7,500 individual terms.

Commonly referred to as "the Rao Guide," this reference has quickly become one of ASME's most popular technical publications -- essential for the many thousands of BPVC users worldwide. Order yours today to help gain full value from the BPVC.

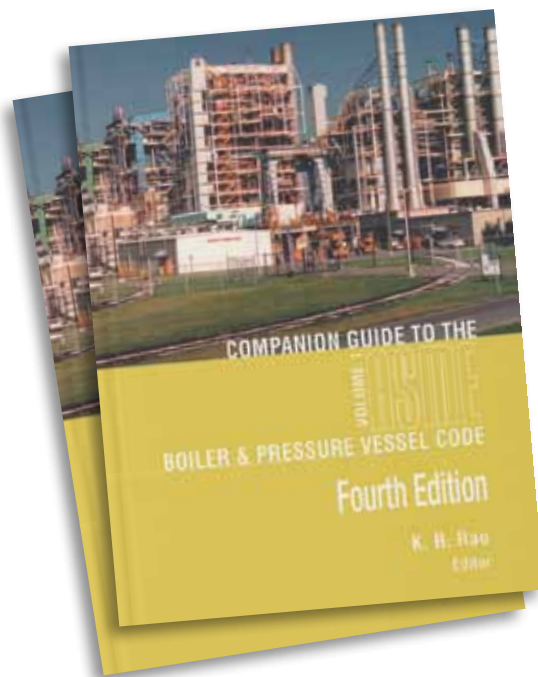

For details, call 1-800-THE-ASME  
(1-800-843-2763) or 1-973-882-1170  
or visit [go.asme.org/bpvc13](http://go.asme.org/bpvc13)