

This is a preview of "BS ISO 15076-1:2010". Click [here](#) to purchase the full version from the ANSI store.

**BS ISO 15076-1:2010**



BSI Standards Publication

# Image technology colour management — Architecture, profile format and data structure

Part 1: Based on ICC.1:2010

NO COPYING WITHOUT BSI PERMISSION EXCEPT AS PERMITTED BY COPYRIGHT LAW

*raising standards worldwide*™



This is a preview of "BS ISO 15076-1:2010". [Click here to purchase the full version from the ANSI store.](#)

This British Standard is the UK implementation of ISO 15076-1:2010. It supersedes BS ISO 15076-1:2005 which is withdrawn.

The UK participation in its preparation was entrusted to Technical Committee PAI/43, Graphic technology.

A list of organizations represented on this committee can be obtained on request to its secretary.

This publication does not purport to include all the necessary provisions of a contract. Users are responsible for its correct application.

© BSI 2010

ISBN 978 0 580 68401 2

ICS 37.100.99

**Compliance with a British Standard cannot confer immunity from legal obligations.**

This British Standard was published under the authority of the Standards Policy and Strategy Committee on 31 December 2010.

**Amendments issued since publication**

Date	Text affected
------	---------------

---

This is a preview of "BS ISO 15076-1:2010". [Click here to purchase the full version from the ANSI store.](#)

Second edition  
2010-12-01

---

---

## **Image technology colour management — Architecture, profile format and data structure —**

### **Part 1: Based on ICC.1:2010**

*Gestion de couleur en technologie d'image — Architecture, format de  
profil et structure de données —*

*Partie 1: Fondé sur l'ICC.1:2010*



Reference number  
ISO 15076-1:2010(E)

© ISO 2010

This is a preview of "BS ISO 15076-1:2010". [Click here to purchase the full version from the ANSI store.](#)

**PDF disclaimer**

This PDF file may contain embedded typefaces. In accordance with Adobe's licensing policy, this file may be printed or viewed but shall not be edited unless the typefaces which are embedded are licensed to and installed on the computer performing the editing. In downloading this file, parties accept therein the responsibility of not infringing Adobe's licensing policy. The ISO Central Secretariat accepts no liability in this area.

Adobe is a trademark of Adobe Systems Incorporated.

Details of the software products used to create this PDF file can be found in the General Info relative to the file; the PDF-creation parameters were optimized for printing. Every care has been taken to ensure that the file is suitable for use by ISO member bodies. In the unlikely event that a problem relating to it is found, please inform the Central Secretariat at the address given below.



**COPYRIGHT PROTECTED DOCUMENT**

© ISO 2010

All rights reserved. Unless otherwise specified, no part of this publication may be reproduced or utilized in any form or by any means, electronic or mechanical, including photocopying and microfilm, without permission in writing from either ISO at the address below or ISO's member body in the country of the requester.

ISO copyright office  
Case postale 56 • CH-1211 Geneva 20  
Tel. + 41 22 749 01 11  
Fax + 41 22 749 09 47  
E-mail [copyright@iso.org](mailto:copyright@iso.org)  
Web [www.iso.org](http://www.iso.org)

Published in Switzerland

This is a preview of "BS ISO 15076-1:2010". [Click here to purchase the full version from the ANSI store.](#)

## Contents

Page

Foreword .....	v
Introduction.....	vi
1 Scope .....	1
2 Normative references .....	1
3 Terms, definitions and abbreviated terms .....	2
3.1 Terms and definitions .....	2
3.2 Abbreviated terms .....	5
4 Basic number types .....	6
4.1 General .....	6
4.2 dateTimeNumber .....	6
4.3 float32Number .....	7
4.4 positionNumber .....	7
4.5 response16Number .....	7
4.6 s15Fixed16Number .....	7
4.7 u16Fixed16Number .....	8
4.8 u1Fixed15Number .....	8
4.9 u8Fixed8Number .....	8
4.10 uint16Number .....	8
4.11 uint32Number .....	8
4.12 uint64Number .....	8
4.13 uint8Number .....	8
4.14 XYZNumber .....	9
4.15 Seven-bit ASCII.....	9
5 Conformance .....	9
6 Profile connection space, rendering intents, and device encoding .....	9
6.1 General considerations.....	9
6.2 Rendering intents .....	10
6.3 Profile connection space.....	11
6.4 Converting between PCSXYZ and PCSLAB encodings .....	17
6.5 Device encoding.....	17
7 Profile requirements.....	18
7.1 General .....	18
7.2 Profile header.....	19
7.3 Tag table.....	24
7.4 Tag data.....	25
8 Required tags.....	25
8.1 General .....	25
8.2 Common requirements .....	25
8.3 Input profiles.....	26
8.4 Display profiles.....	27
8.5 Output profiles.....	28
8.6 DeviceLink profile.....	29
8.7 ColorSpace profile.....	29
8.8 Abstract profile .....	30
8.9 NamedColor profile .....	30
8.10 Precedence order of tag usage.....	30
9 Tag definitions .....	31

This is a preview of "BS ISO 15076-1:2010". [Click here to purchase the full version from the ANSI store.](#)

9.1	General.....	31
9.2	Tag listing .....	32
10	Tag type definitions .....	45
10.1	General.....	45
10.2	chromaticityType .....	45
10.3	colorantOrderType.....	46
10.4	colorantTableType .....	46
10.5	curveType .....	47
10.6	dataType .....	48
10.7	dateTimeType.....	48
10.8	lut16Type .....	49
10.9	lut8Type .....	52
10.10	lutAToBType.....	54
10.11	lutBToAType.....	57
10.12	measurementType .....	60
10.13	multiLocalizedUnicodeType .....	61
10.14	multiProcessElementsType.....	62
10.15	namedColor2Type.....	68
10.16	parametricCurveType.....	69
10.17	profileSequenceDescType .....	70
10.18	profileSequenceIdentifierType .....	71
10.19	responseCurveSet16Type.....	72
10.20	s15Fixed16ArrayType.....	75
10.21	signatureType .....	75
10.22	textType .....	75
10.23	u16Fixed16ArrayType .....	76
10.24	ulnt16ArrayType.....	76
10.25	ulnt32ArrayType.....	76
10.26	ulnt64ArrayType.....	77
10.27	ulnt8ArrayType.....	77
10.28	viewingConditionsType .....	77
10.29	XYZType.....	78
Annex A (informative) Data colour encodings and rendering intents .....		79
Annex B (informative) Embedding profiles.....		83
Annex C (informative) Relationship between ICC profiles and PostScript CSAs and CRDs .....		87
Annex D (informative) Profile connection space .....		89
Annex E (informative) Chromatic adaptation tag.....		102
Annex F (normative) Profile computational models.....		105
Annex G (informative) Tables of required tags and tag list .....		107
Bibliography .....		113

This is a preview of "BS ISO 15076-1:2010". [Click here to purchase the full version from the ANSI store.](#)

## Foreword

ISO (the International Organization for Standardization) is a worldwide federation of national standards bodies (ISO member bodies). The work of preparing International Standards is normally carried out through ISO technical committees. Each member body interested in a subject for which a technical committee has been established has the right to be represented on that committee. International organizations, governmental and non-governmental, in liaison with ISO, also take part in the work. ISO collaborates closely with the International Electrotechnical Commission (IEC) on all matters of electrotechnical standardization.

International Standards are drafted in accordance with the rules given in the ISO/IEC Directives, Part 2.

The main task of technical committees is to prepare International Standards. Draft International Standards adopted by the technical committees are circulated to the member bodies for voting. Publication as an International Standard requires approval by at least 75 % of the member bodies casting a vote.

Attention is drawn to the possibility that some of the elements of this document may be the subject of patent rights. ISO shall not be held responsible for identifying any or all such patent rights.

ISO 15076-1 was prepared by the *International Color Consortium*, in cooperation with Technical Committees ISO/TC 130 *Graphic technology* and ISO/TC 42 *Photography*, under the provisions of the Cooperative Agreement between ISO/TC130 and the *International Color Consortium* dated 2003-07-11.

This second edition cancels and replaces the first edition (ISO 15076-1:2005), which has been technically revised to incorporate changes made in the profile specification. These include the addition of the perceptual intent reference medium colour gamut, new technology signatures, a floating-point device encoding range, a colorimetric intent image state tag, and a profile sequence identifier tag. In addition, the `mediaBlackPointTag` has been deleted and `PCSXYZ` is no longer limited to the PCS illuminant.

ISO 15076-1 is technically identical to ICC.1:2010, *Image technology colour management — Architecture, profile format, and data structure (Profile version 4.3.0.0)*.

ISO 15076 consists of the following parts, under the general title *Image technology colour management — Architecture, profile format and data structure*:

— *Part 1: Based on ICC.1:2010*

## Introduction

### 0.1 General

This part of ISO 15076 specifies the profile format defined by the International Color Consortium<sup>®</sup> (ICC). The intent of this format is to provide a cross-platform profile format for the creation and interpretation of colour data. Such profiles can be used to translate between different colour encodings, and to transform colour data created using one device into another device's native colour encoding. The acceptance of this format by application and operating system vendors allows end users to transparently move profiles, and images with embedded profiles, between different systems. For example, this allows a printer manufacturer to create a single profile for multiple applications and operating systems.

It is assumed that the reader of this part of ISO 15076 has a good understanding of colour science and imaging, such as familiarity with CIE, ISO and IEC colour standards, general knowledge of device measurement and characterization, and familiarity with at least one operating system level colour management system.

### 0.2 International Color Consortium

The International Color Consortium was formed with the primary intent of developing and administering a colour profile format standard, and for the registration of the associated tag signatures and descriptions. The founding members of this consortium were Adobe Systems Inc., Agfa-Gevaert N.V., Apple Computer, Inc., Eastman Kodak Company, FOGRA (Honorary), Microsoft Corporation, Silicon Graphics, Inc., Sun Microsystems, Inc., and Taligent, Inc. These companies committed to fully support the standard in their operating systems, platforms and applications. The consortium has since been expanded and now has over 60 members.

The initial version of the standard developed by the ICC has undergone various revisions, and it was agreed by the ICC that its revision 4.2 first be proposed as an International Standard. It is that revision which formed the basis of first edition of this part of ISO 15076 (ISO 15076-1:2005). This second edition is based on ICC revision 4.3, which is a minor ICC revision and is therefore fully backward compatible with 4.2. All the technical specifications contained in the first edition (ISO 15076-1:2005) are also given in this second edition, and new specifications exclusive to this second edition are clearly identified. Informative material has also been updated and clarified. The ICC will continue to administer its own version of ICC.1:2010 and, if enhancements are made, will be seriously considered for future revisions of this part of ISO 15076. ISO/TC 130 will work to ensure that there are no significant differences between the ICC and ISO versions of this part of ISO 15076.

The ICC web site ([www.color.org](http://www.color.org)) provides supplementary information relevant to this part of ISO 15076 and additional resources for developers and users. It also provides information on how to become a member of ICC.

### 0.3 Colour management architecture and profile connection space

The underlying architecture assumed in this part of ISO 15076 is based around a reference colour space that is unambiguously defined. The colour specification method selected was that defined by CIE which is internationally accepted. The CIE system enables a set of tristimulus values (CIEXYZ) to be specified for a coloured stimulus. These tristimulus values enable a user to determine whether colours match in appearance when viewed by a typical observer in a specific viewing environment. It follows that it is possible to define the colour appearance of a sample by these tristimulus values (or some defined transformation of them) for a specified state of viewer adaptation. The colour appearance is simply the appearance of the colour to a typical human observer, as opposed to the physical characteristics of the colour stimulus, which is not fully specified using tristimulus values.



This is a preview of "BS ISO 15076-1:2010". [Click here to purchase the full version from the ANSI store.](#)

Calculation of the CIEXYZ values for transmitting or reflecting media is achieved from the spectral sum-product of the reflectance or transmittance of the sample, the relative spectral power distribution of the illumination source used to view it and the spectral 'sensitivity' of the standard observer. However, as CIE defines two standard observers, two measurement geometries (for reflecting media) and a large number of standard illuminants, it is necessary to restrict these options in order to have a colour specification system that is not ambiguous for a particular application. For this part of ISO 15076, the ICC has defined such a restriction, based on ISO 13655, and the resultant colour spaces are known as PCSXYZ and PCSLAB. Furthermore, the simple CIE system (whether CIEXYZ or the CIELAB values derived from them) does not accommodate the effect of surrounding stimuli to the sample being measured (which can be different for various types of media) or the illumination. Both of these affect appearance so the PCS values do not by themselves specify appearance. To overcome this problem, the PCS is used in two different ways. The first accounts only for the assumed state of chromatic adaptation of the viewer, and describes the colorimetry of actual originals and their reproductions, chromatically adapted to the PCS adopted white chromaticity, through the colorimetric rendering intents. The second, which describes the colorimetry of an image colour rendered to a standard reference medium under a specified viewing condition, is employed for the perceptual rendering intent and optionally for the saturation rendering intent. Thus, it can incorporate corrections for different states of viewer adaptation and other desired rendering effects, as well as accommodating differences between actual colour encoding and device dynamic ranges and colour gamuts, and those of the perceptual intent reference medium. When required, the viewing conditions can be specified to allow colour appearance to be determined for the colorimetric rendering intents.

So, in summary, the PCS is based on CIEXYZ (or CIELAB) determined for a specific observer (CIE Standard 1931 Colorimetric Observer, often known colloquially as the 2 degree observer), relative to a specific illuminant chromaticity (that of CIE D50), and measured with a specified measurement geometry (0°:45° or 45°:0°), for reflecting media. Measurement procedures are also defined for transmitting and self-luminous media. Since the conversion from CIEXYZ to CIELAB is quite unambiguous, profile builders can use either colour space for the PCS; the colour management system is able to determine which has been used from a tag in the header.

For colorimetric renderings where the measured data were not obtained relative to a D50 adopted white chromaticity, the profile builder is expected to adapt the data to achieve this. Therefore, a mechanism for identifying the chromatic adaptation used in such situations is provided. For the perceptual rendering intent the viewing conditions and reference medium are specified in order to provide a clear target for colour rendering and re-rendering (including gamut mapping). In the following paragraphs, the reference colour space, to which reference is made, needs to include the viewing conditions and reference medium when the perceptual intent is being considered. For the perceptual rendering intent, profile builders are expected to undertake any corrections for appearance effects if the viewing conditions used for monitors and transmitting media (such as dark surrounds) differ from those typical for reflecting media, and to account for differences between actual media and the reference medium.

Figure 1 shows how a reference colour space can be used to provide the common interface for transformations between different colour encodings, as used by different devices, or even different operational modes of the same device. Without it, a separate transformation would be required for each pair of device modes. If there are  $n$  device modes to be supported in a system, and it is necessary to provide a transformation between each pair of device modes,  $n^2$  transforms would need to be defined and  $n$  new transforms would need to be defined every time a new device mode was added. As a new printer device mode can consist simply of a new paper type, this is not a practical solution. By using a reference colour space, only  $n$  transforms need be defined and only one new transform needs to be defined each time a new device mode is added; whatever device-to-device transforms are needed can be constructed by linking the source and destination profiles using the reference colour space as the interface.

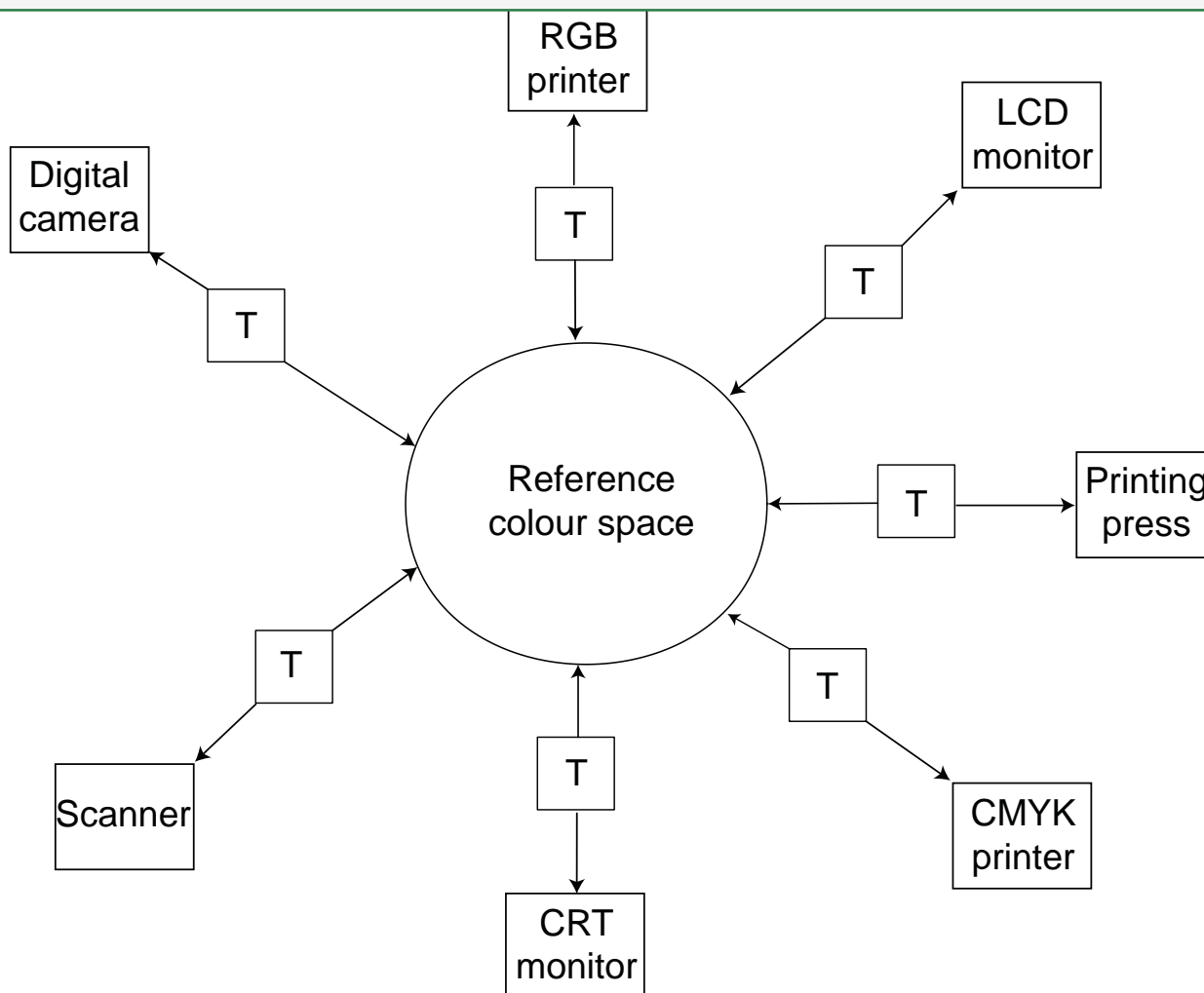

**Key**

T colour management transform

**Figure 1 — Use of a reference colour space**

While images can be encoded directly in PCSXYZ or PCSLAB, this will not generally be the case. A number of colour encodings for open exchange have been standardized to meet a variety of needs. Depending on the use case, different bit depths, image states, reference media and colour gamuts are needed. Devices also have different characteristics resulting in different native encodings. Except for a few cases where default encodings for key system devices are used for exchange (like the sRGB encoding), it is not practical or productive to attempt to restrict system colour encoding support.

For reasons of precision, it is usually desirable to define the transformation between the colour data encoding and the profile connection space (PCS) at a high precision. If the transformation between a colour data encoding and the PCS is provided with an image file, it can be utilized when images are reproduced. In order that the transformation between the colour data encoding and the PCS can be interpreted by all applications it is important that it be defined in an open specification. The profile format defined in this part of ISO 15076 provides that specification.

#### 0.4 Rendering intents

In general, actual device colour gamuts will fail to match each other, and that of the perceptual intent reference medium, to varying degrees. Because of this mismatch, and because of the needs of different applications, four rendering intents (colour rendering styles) are defined in this part of ISO 15076. Each one represents a different colour reproduction objective. The colorimetric rendering intents operate directly on

This is a preview of "BS ISO 15076-1:2010". [Click here to purchase the full version from the ANSI store.](#)

measured colorimetric values, with correction for chromatic adaptation when the measured values were not obtained relative to the PCS adopted white chromaticity. The other rendering intents (perceptual and saturation) operate on colorimetric values which are adjusted in an as-needed fashion to account for any differences between devices, media, and viewing conditions.

Two colorimetric rendering intents are specified in this part of ISO 15076, though only one is included fully constructed in the profile. The included media relative colorimetric intent is based on media-relative colorimetry, which is normalized relative to the unprinted media white for reflecting, transmitting, and self luminous media, or, in the case of colour encodings and capture, to the colour encoding values that correspond to the highest perceived brightness. Thus the media white will have the values of 100, 0, 0 in PCSLAB. This ensures that highlight clipping will not occur when the media-relative colorimetric intent is used. The use of media-relative colorimetry enables colour reproductions to be defined which maintain highlight detail, while keeping the medium 'white', even when the original and reproduction media differ in colour. However, this rendering intent introduces some change in all colours in the reproduction when the media whites of the source and destination do not match.

The PCS adopted white is defined to be the radiance of a perfect reflecting diffuser illuminated by a source with a spectral power distribution matching that of CIE Illuminant D50. ICC profiles contain the values of the media white, adapted to be relative to the chromaticity of the PCS adopted white. For the ICC-absolute colorimetric rendering intent, all of the colorimetric values are re-calculated to be relative to the tristimulus values of the PCS adopted white. When source and destination viewing conditions are identical and an exact colour match is required for all within-gamut colours (including the source medium colour), the ICC-absolute colorimetric rendering intent should be used. This rendering intent can also be useful in other situations.

The colour rendering of the perceptual and saturation rendering intents is vendor specific. The former, which is useful for general reproduction of pictorial images, typically includes tone scale adjustments to map the dynamic range of one medium to that of another, and gamut reshaping and mapping to deal with gamut mismatches. The latter has historically been useful for images which contain objects such as charts or diagrams, and usually involves compromises such as trading off preservation of hue in order to preserve the vividness of pure colours. As the saturation rendering intent is neither required to contain colorimetric characterization information or to use the perceptual intent reference medium, it is the only option, in proprietary systems, for providing colour rendering and re-rendering transforms to and from custom reference media represented in the PCS. For broader interoperability when using the saturation rendering intent, the perceptual reference medium can be used, and its use indicated.

For perceptual transforms it is necessary, in order to optimize colour rendering, to provide a realistic target for the colour rendering. For this reason, a reference medium and reference viewing condition have been defined which apply only to the perceptual rendering. The reference medium is defined as a hypothetical reflection print on a substrate with a white having a neutral reflectance of 89 %, and a density range of 2,459 3. The reference viewing condition is the P2 condition specified in ISO 3664, i.e. D50 at 500 lx for viewing reflecting media. A neutral surround of 20 % reflectance is assumed. The colour gamut of the reference medium is qualitatively specified as that of a reflection print, and whatever colour gamut is used in the PCS is required to be consistent with the specified dynamic range of the perceptual reference medium. It is recommended that the reference gamut specified in ISO 12640-3 be used as a more explicit target gamut for improved interoperability. Profile creators should consider this gamut to be the target for perceptual intent colour rendering and re-rendering to the PCS. Likewise, the perceptual intent colour re-rendering from the PCS needs to assume this gamut as the starting gamut for colour re-rendering to the destination medium. However, even when the use of this gamut is indicated, perceptual intent transforms need to be designed to produce the best visual results, and need not conform exactly to this gamut in the PCS.

The choice of a reference medium with a realistic black point for the perceptual intent provides a well-defined aim when colour rendering or re-rendering are required. Inputs with a dynamic range greater than a reflection print (e.g. a slide film image, or the colorimetry of high-range scenes) can have their highlights and shadows smoothly compressed to the range of the reference medium in such a way that these regions can be expanded again without undue loss of detail on output to wide-range media. Likewise, images from original media with limited dynamic range can be colour re-rendered to the expanded dynamic range of the reference medium, in order to produce better quality in subsequent reproductions. Bi-directional transform pairs (e.g. data-to-PCS and PCS-to-data for each rendering intent) in the profiles can be used to undo prior PCS-to-data colour re-rendering so that a differently optimized reproduction can be produced for a different reproduction medium.

This is a preview of "BS ISO 15076-1:2010". [Click here to purchase the full version from the ANSI store.](#)

Profiles generally offer different transformations for different rendering intents. When the rendering intent is selected the corresponding transformation is selected by the colour management system. The choice of rendering intent is highly dependent upon the intended use. In general, the perceptual rendering intent is most applicable for the colour re-rendering of natural images, to make pleasing and aesthetically similar, but not exactly matching, reproductions on different media. The ICC-absolute colorimetric rendering intent is most appropriate for a proofing environment, where the colour reproduction obtained on one device is simulated on another. The media-relative colorimetric rendering intent is appropriate when mapping of the source medium white to the destination medium white is desired, but a full colour re-rendering is not.

For those requiring further information, an extended discussion of many of the issues described above is provided in Annex D.

### 0.5 Colour profiles

Colour profiles provide colour management systems with the information necessary to convert colour data between different colour encodings, including device encodings. This part of ISO 15076 divides colour devices into three broad classifications, i.e. input devices, display devices and output devices. For each device class, a series of base algorithmic models are described which perform the transformation between colour encodings. Figures 2 and 3 show examples of these models, which provide different trade-offs in memory footprint, colour quality and performance results. The matrix tone reproduction curve (TRC) model is explained in detail in 8.3.3 and 8.4.3, the lutAToBType and lutBToAType in 10.10 and 10.11, and the multiProcessElementsType in 10.14. The necessary parameter data to implement these models is described in the appropriate tag type descriptions in Clause 10. This required data provides the information for the colour management framework default colour management module (CMM) to transform colour information between colour encodings. A representative architecture using these components is illustrated in Figure 4.

NOTE Only the models shown in Figures 2d), 2e), 2f), 3d), 3e) and 3f) can be used if the device space has more than three components/colours.

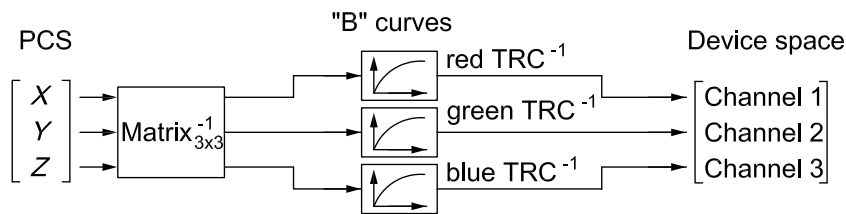

a) Using a matrix/TRC model

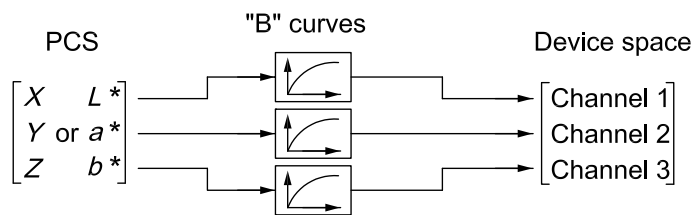

b) Using a lutBToAType model

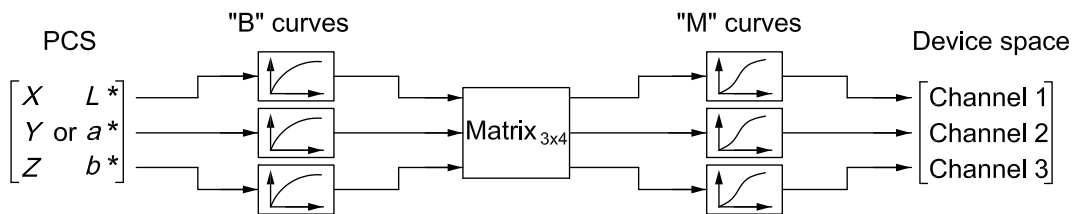

c) Using a lutBToAType model

This is a preview of "BS ISO 15076-1:2010". Click here to purchase the full version from the ANSI store.

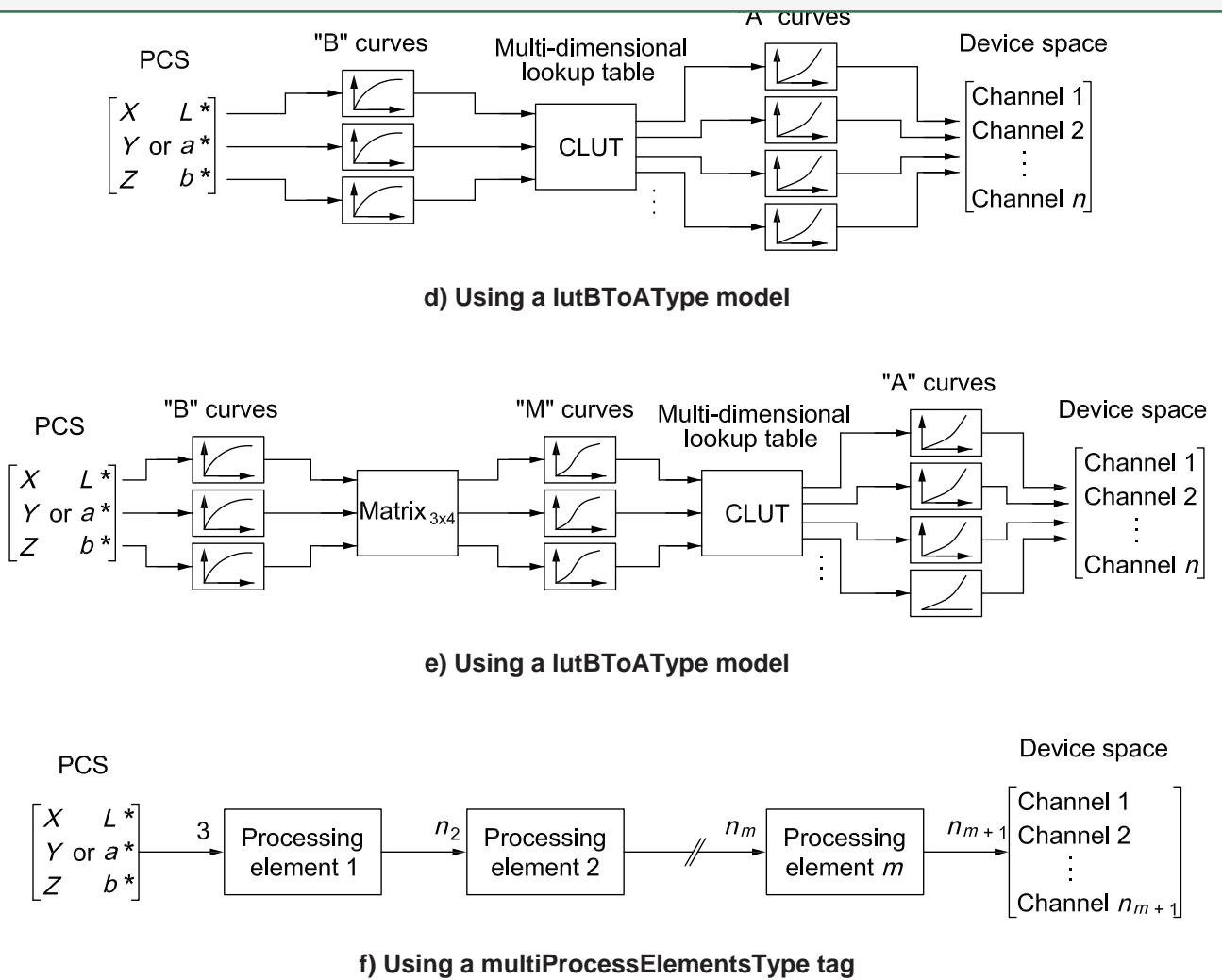
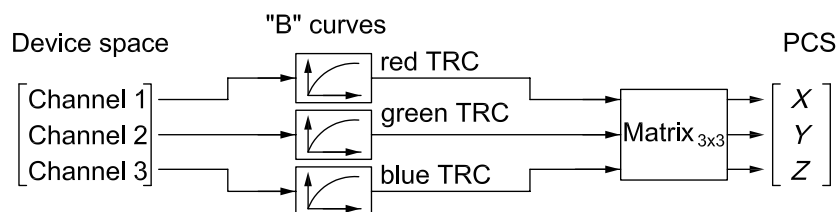
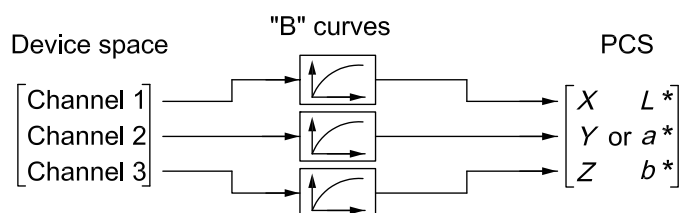

Figure 2 — Examples of different ways of converting a colour from PCS to device space



a) Using a matrix/TRC model



b) Using a lutAToBType model

This is a preview of "BS ISO 15076-1:2010". Click here to purchase the full version from the ANSI store.

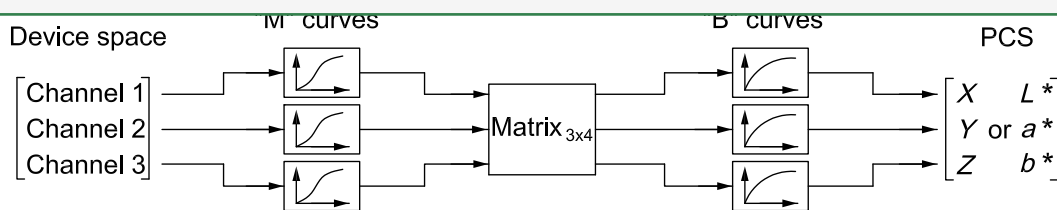

c) Using a lutBToAType model

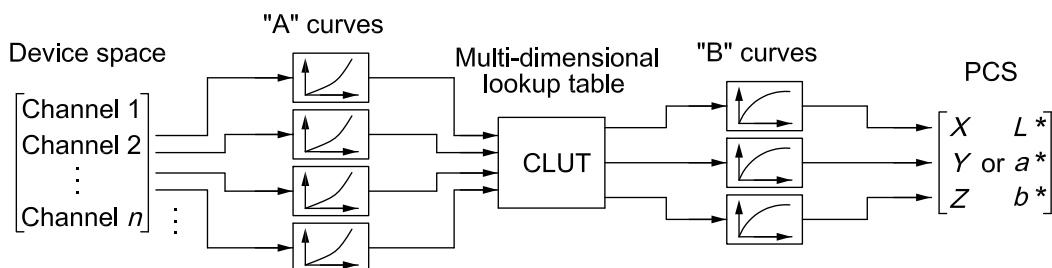

d) Using a lutBToAType model

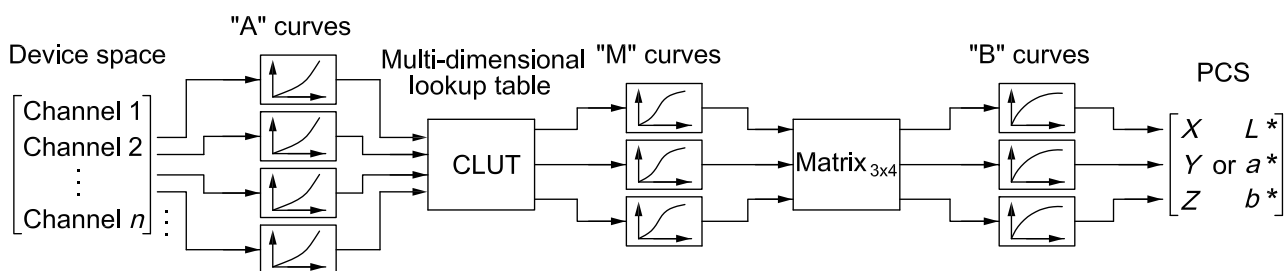

e) Using a lutBToAType model

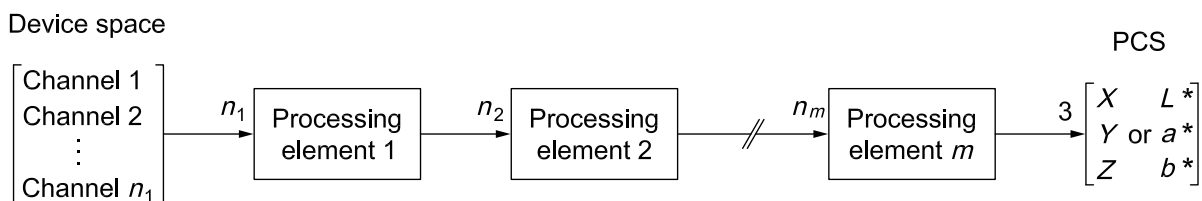

f) Using a multiProcessElementsType tag

Figure 3 — Examples of different ways of converting a colour from device to PCS

This is a preview of "BS ISO 15076-1:2010". [Click here to purchase the full version from the ANSI store.](#)

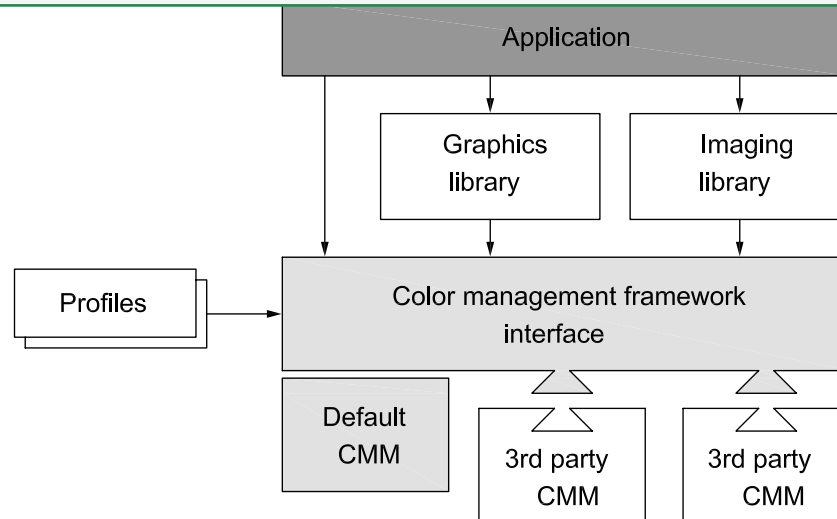

Figure 4 — Colour management architecture

## 0.6 Profile element structure

The profile structure is defined as a header followed by a tag table followed by a series of tagged elements that can be accessed randomly and individually. This collection of tagged elements provides three levels of information for developers: required data, optional data and private data. An element tag table provides a table of contents for the tagging information in each individual profile. This table includes a tag signature, the beginning address offset and size of the data for each individual tagged element. Signatures in this part of ISO 15076 are defined as a 4-byte hexadecimal number. This tagging scheme allows developers to read in the element tag table and then randomly access and load into memory only the information necessary to their particular software application. Since some instances of profiles can be quite large, this provides significant savings in performance and memory. The detailed descriptions of the tags, along with their intent, are included later in this part of ISO 15076.

The required tags provide the complete set of information necessary for the CMM to translate colour information between the PCS and the data colour encoding. Each profile class determines which combination of tags is required.

In addition to the required tags for each colour profile, a number of optional tags are defined that can be used for enhanced capabilities. In the case of required and optional tags, all of the signatures, an algorithmic description (where appropriate), and intent are registered with the International Color Consortium. Private data tags allow CMM developers to add proprietary value to their profiles. By registering just the tag signature and tag type signature, developers are assured of maintaining their proprietary advantages while maintaining compatibility with this part of ISO 15076. However, since the overall philosophy of this format is to maintain an open, cross-platform standard, developers are encouraged to keep the use of private tags to an absolute minimum.

## 0.7 Embedded profiles

In addition to providing a cross-platform standard for the colour profile format, this part of ISO 15076 also describes the convention for embedding these profiles within graphics documents and images. Embedded profiles allow users to transparently move colour data between different computers, networks and even operating systems without having to worry if the necessary profiles are present on the destination systems. The intention of embedded profiles is to allow the interpretation of the associated colour data. Embedding profiles are described in Annex B of this part of ISO 15076.



This is a preview of "BS ISO 15076-1:2010". [Click here to purchase the full version from the ANSI store.](#)

**0.8 Other profiles**

Four profile types, in addition to the device profile types described above, are defined in this part of ISO 15076. DeviceLink profiles provide a dedicated transformation from one device encoding to another, which can be useful in situations where such a transformation is used frequently or has required optimisation to achieve specific objectives. (Figure 5 shows the various algorithmic models which can be used to construct a DeviceLink profile.)

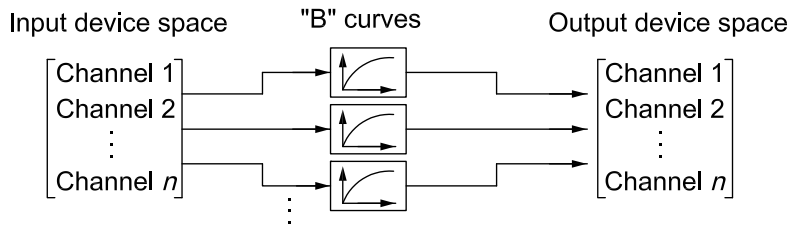

**a) Using a TRC model**

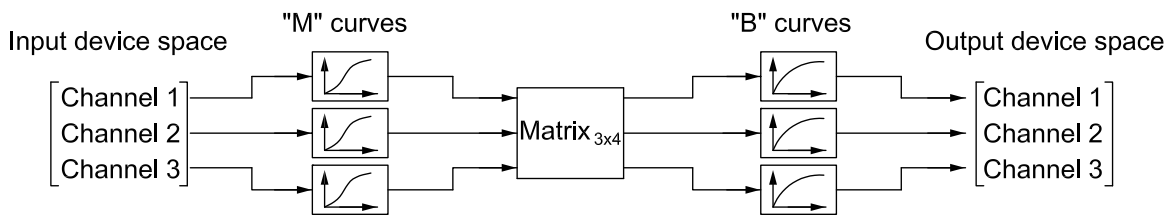

**b) Using a matrix and TRC model**

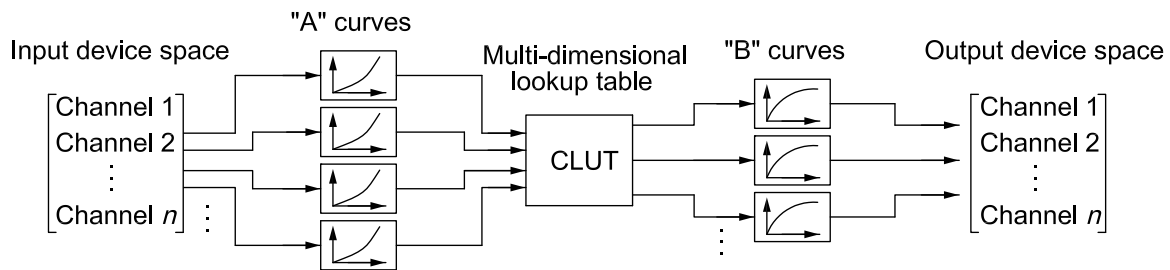

**c) Using a colour lookup table (CLUT), and a TRC model**

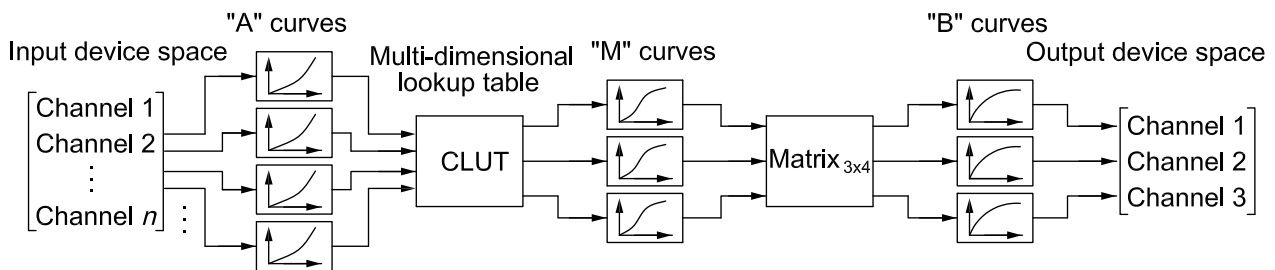

**d) Using a CLUT, a matrix, and a TRC model**



This is a preview of "BS ISO 15076-1:2010". [Click here to purchase the full version from the ANSI store.](#)

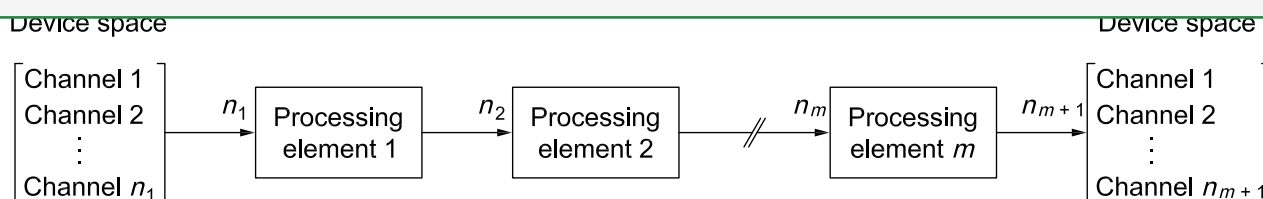

e) Using a multiProcessElementsType tag

**Figure 5 — Examples of converting a colour from device to device using a DeviceLink profile**

ColorSpace profiles provide transformations between standard colour encodings and the PCS, providing a means for supporting existing and future colour encodings with backward compatibility. Abstract profiles are defined from PCS to PCS and enable colour transformations to be defined that provide some specific colour effects. NamedColor profiles provide a mechanism for specifying the relationship between device values and the PCS for specific colours, rather than for general images.

## 0.9 Organizational description of this part of ISO 15076

This part of ISO 15076 addresses a very complex set of issues and it has been organized to provide a clear, clean, and unambiguous explanation of the entire format. To accomplish this, the overall presentation is from a top-down perspective, beginning with the summary overview presented above, followed by the necessary background information and definitions needed for unambiguous interpretation of the text. A description of the PCS and rendering intents is then provided before continuing down at increasing levels of detail into a byte stream description of the format. Clause 6 describes the PCS and rendering intents; Clause 7 describes the structure of the various fields required in a profile; and Clause 8 describes the content of the required tags for each profile class. Clause 9 lists the various tags (optional and required) and briefly summarizes the function of the tags as well as listing the signature and permitted tag types for each. The tag types are defined in Clause 10. Annex A provides additional information pertaining to the data colour encodings and rendering intents used in this part of ISO 15076 while Annex B provides details for embedding profiles into EPS, TIFF, and JPEG files. Annex C provides a general description of the PostScript Level 2 tags used in this part of ISO 15076 while Annex D provides some background material on the PCS. Annex E provides additional information pertaining to chromatic adaptation and the chromaticAdaptationTag while Annex F describes some computational models assumed in this part of ISO 15076. Annex G summarizes in tabular form the required tags for each profile class as specified in Clause 8.

## 0.10 Patent statement

The International Organization for Standardization (ISO) draws attention to the fact that it is claimed that compliance with this part of ISO 15076 can involve the use of a patent concerning the outputResponseTag, (support of the outputResponseTag is optional), given in 9.2.36.

ISO takes no position concerning the evidence, validity and scope of this patent right. The holder of this patent right has assured the ISO that he is willing to negotiate licences under reasonable and non-discriminatory terms and conditions with applicants throughout the world. In this respect, the statement of the holder of this patent right is registered with ISO. Information may be obtained from:

Intellectual Property Standards and Transactions  
Eastman Kodak Company  
343 State Street,  
Rochester, NY 14650  
USA

Attention is drawn to the possibility that some of the elements of this part of ISO 15076 may be the subject of patent rights other than those identified above. ISO shall not be held responsible for identifying any or all such patent rights.

This is a preview of "BS ISO 15076-1:2010". [Click here to purchase the full version from the ANSI store.](#)

This is a preview of "BS ISO 15076-1:2010". Click here to purchase the full version from the ANSI store.

# Image technology colour management — Architecture, profile format and data structure —

## Part 1: Based on ICC.1:2010

### 1 Scope

This part of ISO 15076 specifies a colour profile format and describes the architecture within which it can operate. This architecture supports the exchange of information which specifies the intended colour image processing of digital data. The required reference colour spaces and the data structures (tags) are also specified.

NOTE The technical content of this part of ISO 15076 is identical to that of ICC.1:2010.

### 2 Normative references

The following referenced documents are indispensable for the application of this document. For dated references, only the edition cited applies. For undated references, the latest edition of the referenced document (including any amendments) applies.

ISO 5-3, *Photography and graphic technology — Density measurements — Part 3: Spectral conditions*

ISO 639-1, *Codes for the representation of names of languages — Part 1: Alpha-2 code*

ISO/IEC 646, *Information technology — ISO 7-bit coded character set for information interchange*

ISO 3166-1, *Codes for the representation of names of countries and their subdivisions — Part 1: Country codes*

ISO 3664, *Graphic technology and photography — Viewing conditions*

ISO 13655, *Graphic technology — Spectral measurement and colorimetric computation for graphic arts images*

DIN 16536-2, *Testing of prints and printing inks in graphic technology — Colour density measurements on on-press or off-press prints — Part 2: Instrument specifications for reflection densitometers and their calibration*

EBU Tech. 3213-E, *EBU standard for chromaticity tolerances for studio monitors*

ITU-R BT.709-2, *Parameter values for the HDTV standards for production and international programme exchange*

SMPTE RP 145, *SMPTE C Color Monitor Colorimetry*. Available from: <<http://store.smpte.org/category-s/22.htm>>

Internet RFC 1321, *The MD5 Message-Digest Algorithm*, R. Rivest, April 1992, Available from Internet <<ftp://www.ietf.org/rfc/rfc1321.txt>>

IEEE 754, *Standard for Binary Floating-Point Arithmetic*. Available from: <<http://ieeexplore.ieee.org>>